

اتوماسیون صنعتی (اینورتر)



**دیزل نیرو**

واردات و فروش انواع اینورترهای صنعتی



Variable Frequency Drive / Inverter  
**STARVERT i55**

0.75 -55kW(1-75HP) 3 phase 200 -230Volts  
0.75 -75kW(1-100HP) 3 phase 380 -460Volts





## Contents

Overview	02
Features & Selection Guide	04
Specifications & Wiring	06
Terminal Configuration, Keypad & Parameter Navigation	08
Program Parameter Descriptions	10
Dimension	18
Options, DB Resistor & Peripheral Devices	20
RFI Filters	22



**Sensorless, sensored vector controlled iS5,  
keeps your application in more stable,  
durable and precise condition.**

## Options

- Communications Board:
  - RS-485
  - DeviceNet
  - F-Net
  - ModBus-RTU
  - ProfiBus DP
  - Extended I/O Module
    - Sub-A Board:
      - 3 Multi-Function Input
      - 3 Multi-Function Output
    - Sub-B Board :
      - Encoder Plus Input
      - Encoder Plus Output
    - Sub-C Board :
      - 3 Multi-Function Input
      - 3 Multi-Function Output
      - Aux. Analog Reference Frequency (Isolated)
- Cable for Remote Keypad Operations
- Dynamic Braking Units for 11~75kW Inverters
- Dynamic Braking Resistors

## Standard features

- kW / Voltage Ratings:
  - 0.75~55kW, 200-230VAC, 3 phase
  - 0.75~75kW, 380-480VAC, 3 phase
- Enclosure: IP00 ~ IP20
- Inverter Type: PWM with IGBT
- Control Method: Sensorless/Sensored Vector
- 1~15kHz Carrier Frequency (1~8kHz. over 30kW)
- 0~400Hz Output Frequency
- Removable Keypad (Able to read & write parameters)
- Intelligent Accel/Decel for Trip-Free Operation
- Auto Tuning
- 8 Multi-Function Inputs
- 1 Multi-Function Outputs
- Failure Relay
- Built-in PID Control
- Pre-Set Speeds
- Wire Operation
- Multi-step Programmable Run Patterns
- Auto Torque Boost
- DC Injection Braking
- Stall Prevention
- Built-In Braking Circuit for 0.75 ~ 7.5kW units

## Application

- Traverse
- Draw
- MMC (Mult Motor Control)
- Converting
- Material Handling
- Web Processing
- Fan/Pump Controls
- Conveyors
- Industrial Washing machine, etc.

## Conformity to global standards

- UL and cUL listed for North America
- CE marked for Europe
- Quality process controlled by ISO9001, ISO14000



## Extended I/O boards

The iS5 has several additional I/O boards that can be easily mounted into the connection terminal on control board. Each I/O board is standardized for a specific I/O requirement. The three main I/O boards are "Sub-board A", "Sub-board B" and "Sub-board C". This helps system engineer to design most adequate and cost effective system using the exactly necessary number of I/Os and functions. It is extendable and changeable in case of system upgrade or change. The control parameters and detailed functions for these boards are not shown until any of them is inserted.

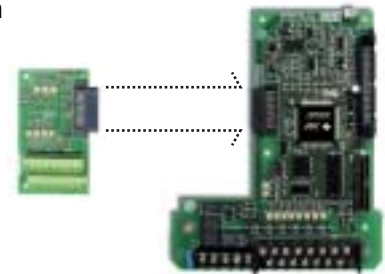

## Diversity of communication interfaces

The iS5 provides most popular communication interfaces such as Device Net, Profibus DP, Modbus-RTU, RS485 and F-Net (LS proprietary protocol for LS PLC communication). The "Driveview™" software offers Window® based computer monitoring tool through RS-485 interface with graphic capture, keypad emulator, parameter edit, and text monitor. It is applicable for all LS inverters.

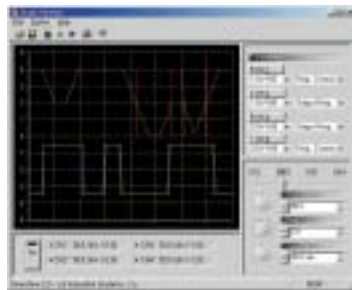

**F-Net™**  
**ModBus-RTU™**  
**DeviceNet™**  
**RS-485**

## Built-in PID control

It is valuable in process control. The built-in PID algorithm controls flow, temperature, pressure, etc. through the proportional, integral and differential calculus between the feedback value and reference value in closed loop. The high speed CPU makes the calculation easy and fast.

## Sensorless vector control

The iS5 adopts sensorless vector control algorithm, and it improves not only the torque control characteristics, but the speed controllability in an uncertain condition caused by the load variation as well.

The iS5 especially generates strong torque at a low speed range as shown below.

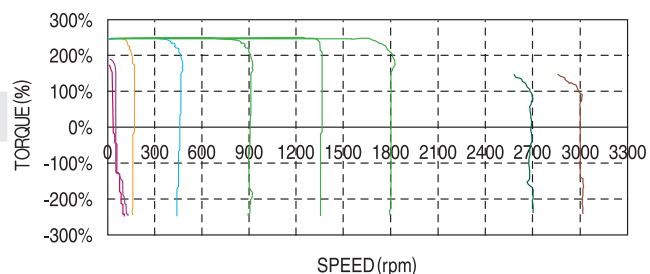
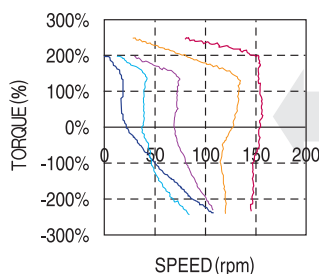

## Auto tuning

The auto tuning algorithm in iS5 sets the motor factors automatically. It brings the traditional commissioning difficulties mainly in low speed by the load variation and the low torque generation to a settlement.

## Optimum acceleration and deceleration

To make a maximum torque during the acceleration and deceleration, so called "trip free" function is acting during acceleration and deceleration. Both of Acceleration and deceleration may cause a trip in case that it is manually programmed. The 32-bit DSP CPU monitors the current transition during the acceleration and deceleration to program an optimum curve that is under the triptrigering level automatically.

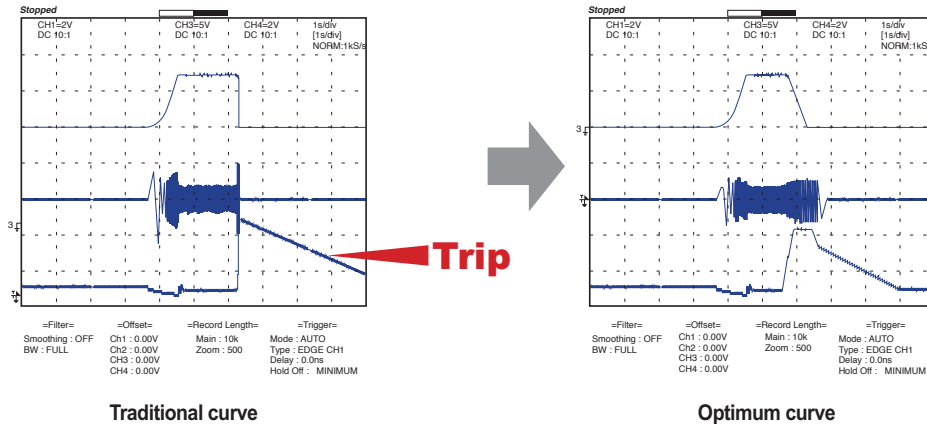

## Inverter rating selection guide

Application motor		200~230V	380~460V
KW	HP		
0.75	1	SV008iS5-2	SV008iS5-4
1.5	2	SV015iS5-2	SV015iS5-4
2.2	3	SV022iS5-2	SV022iS5-4
3.7	5	SV037iS5-2	SV037iS5-4
5.5	7.5	SV055iS5-2	SV055iS5-4
7.5	10	SV110iS5-2	SV110iS5-4
11	15	SV150iS5-2	SV150iS5-4
15	20	SV185iS5-2	SV185iS5-4
18.5	25	SV220iS5-2	SV220iS5-4
22	30	SV300iS5-2	SV300iS5-4
30	40	SV370iS5-2	SV370iS5-4
37	50	SV450iS5-2	SV450iS5-4
45	60	SV550iS5-2	SV550iS5-4
55	75		
75	100		SV750iS5-4

## Inverter type nomenclature

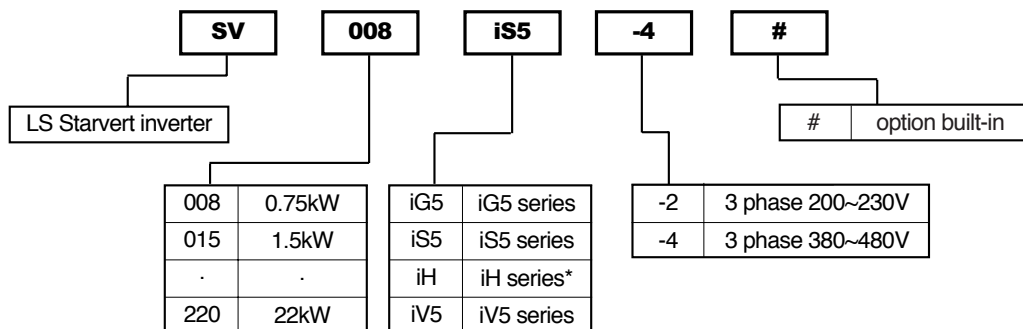

\* iH inverter has a different designation in kW.

## Specifications 200~230V Class (0.75~55kW)

Inverter Type (SV __ iS5-)	008-2	015-2	022-2	037-2	055-2	075-2	110-2	150-2	185-2	220-2	300-2	370-2	450-2	550-2	
Motor Rating*1)	[HP] 1	2	3	5	7.5	10	15	20	25	30	40	50	60	75	
	[kW] 0.75	1.5	2.2	3.7	5.5	7.5	11	15	18.5	22	30	37	45	55	
Output ratings	Capacity[kVA]*2)	1.9	3	4.5	6.1	9.1	12.2	17.5	22.9	28.2	33.5	46	55	68	84
	FLA[A]	5	8	12	16	24	32	46	60	74	88	122	146	180	220
Input ratings	Frequency	0 ~ 400 Hz													
	Voltage	200 ~ 230V*3)													
Input ratings	Voltage	3 phase 200 ~ 230 V (±10%)													
	Frequency	50 ~ 60 Hz (±5%)													
Weight[kg]	4.6	4.6	4.8	4.9	7.5	7.7	13.8	14.3	19.4	20					

## Specifications 380~480V Class (0.75~75kW)

Inverter Type (SV __ iS5-)	008-4	015-4	022-4	037-4	055-4	075-4	110-4	150-4	185-4	220-4	300-4	370-4	450-4	550-4	750-4	
Motor Rating*1)	[HP] 1	2	3	5	7.5	10	15	20	25	30	40	50	60	75	100	
	[kW] 0.75	1.5	2.2	3.7	5.5	7.5	11	15	18.5	22	30	37	45	55	75	
Output ratings	Capacity[kVA]*2)	1.9	3	4.5	6.1	9.1	12.2	18.3	22.9	29.7	34.3	45	56	68	82	100
	FLA[A]	2.5	4	6	8	12	16	24	30	39	45	61	75	91	110	152
Input ratings	Frequency	0 ~ 400 Hz														
	Voltage	380 ~ 480V*3)														
Input ratings	Voltage	3 phase 380 ~ 480 V (±10%)														
	Frequency	50 ~ 60 Hz (±5%)														
Weight[kg]	4.6	4.6	4.8	4.9	7.5	7.7	13.8	14.3	19.4	20						

Braking Torque	Braking circuit	On board					Optional (Braking unit, resistor)					
	Average braking torque	100%					150%					
	Max.continuous braking	5seconds					Controlled by braking unit*4)					
	Max. duty	30 (3)%ED					10 %ED					
Cooling method	Forced air cooling								IP00			

\*1) Indicates the maximum applicable capacity when using 4 pole LS standard motor.

\*2) Rated capacity ( $\sqrt{3} \times V \times I$ ) is based on 220V for 200V class and 440V for 400V class.

\*3) Maximum output voltage will not be greater than the input voltage. Output voltage less than the input voltage can be set.

\*4) 0.75 ~ 3.7kW inverter have internal braking resistor inside. 5.5 ~ 75kW inverters need optional braking resistor.

Control	Control method	V/F control, sensorless vector control(selectable), sensored vector control		
	Frequency setting resolution	Digital reference : 0.01 Hz (below 100 Hz), 0.1 Hz (over 100 Hz)	Analog reference : 0.03 Hz / 50 Hz	
	Frequency accuracy	Digital : 0.01% of max. output frequency	Analog : 0.1% of max. output frequency	
	V/F ratio	Linear, Square pattern, User V/F		
	Overload capacity	150 % of rated current for 1 min., 200% of rated current for 0.5 sec. (characteristic is inversely proportional to time)		
Operation	Torque boost	Manual torque boost (0 ~ 15 %), Auto torque boost		
	Input signal	Operation method	Key / terminal / communication operation	
		Frequency setting	Analog : 0 ~ 10V / 4 ~ 20 mA / Additional port for Sub-board (0 ~ 10V)	
		Start signal	forward, reverse	
		Multi-step	Up to 8 speeds can be set (use multi-function terminal)	
	Input signal	Multi-step accel/decel time	0 ~ 6,000 sec, up to 8 types can be set and selected for each setting (use the multi- function terminal), Accel/Decel pattern : linear pattern, U pattern, S pattern	
		Emergency stop	Interrupts the output of the inverter	
	Output signal	Jog	Jog operation	
		Auto operation	Operates from internal sequence by setting the multi-function terminal (5way x 8step) Trip status is removed when protective function is	
		Fault reset	active	
Operation status		Frequency level detection, Overload alarm, stalling, overvoltage, undervoltage, inverter overheating, running, stop, constant speed, exchange inverter to commercial line, speed searching, auto operation step, auto operation sequence		
Output signal	Fault output	Contact output (30A,30C,30B) - AC250V 1A, DC30V 1A		
	Indicator	Choose 1 from Output frequency, output current, output voltage, DC voltage (Output voltage: 0 ~ 10V)		
	Operation function	DC braking, frequency limit, frequency jump, second function, slip compensation, reverse rotation prevention, auto restart, exchange inverter to commercial line, auto-tuning, PID control		
Protective function	Inverter trip	Overvoltage, undervoltage, overcurrent, fuse open, ground fault, inverter overheating, motor overheating, output phase loss, MC fail (over 30kW only), overload protection, external fault 1,2, communication error, loss of speed command, hardware fault, option fault etc.		
	Inverter alarm	Stall prevention, overload alarm		
	Momentary power loss	Less than 15 msec : continuous operation (over 30kW drives excluded), more than 15 msec : auto restart possible		
Display Keypad	Operation information	Output frequency, output current, output voltage, frequency value setting, operating speed, DC voltage		
	Trip information	Indicates the fault when the protection function activates, memorizes up to 5 faults		
Environment	Ambient temperature	-10 °C ~ 40 °C		
	Storage temperature	-20 °C ~ 65 °C		
	Ambient humidity	90 % RH max.(Non condensing)		
	Altitude . Vibration	Below 1,000 m / below 5.9m/sec <sup>2</sup> (=0.6g)		
Application side	No corrosive gas, combustible gas, oil mist, or dust			

Wiring

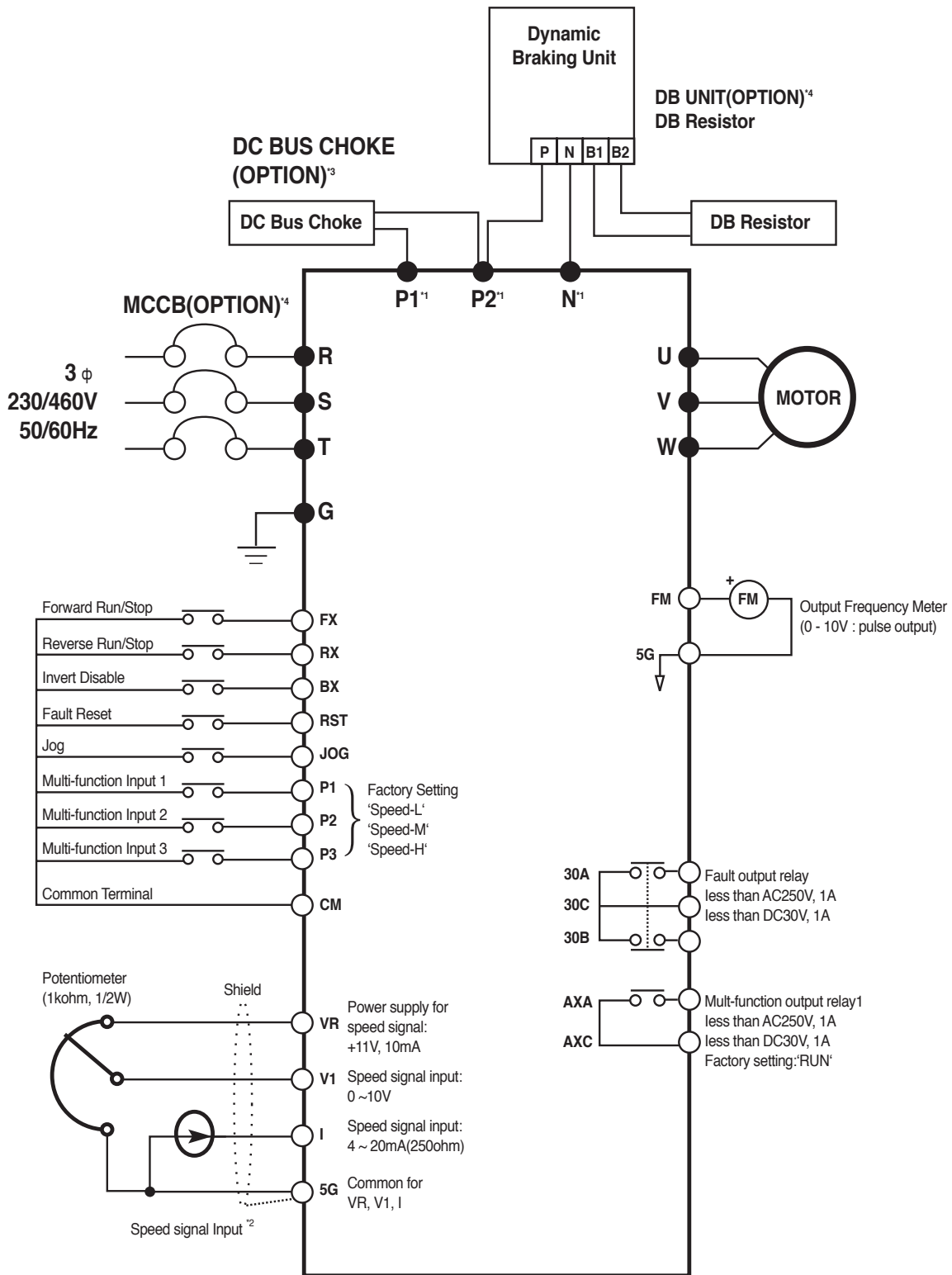

Note) "●" display main circuit terminals, "○" display control circuit terminals.

- The terminal configuration varies depend on the model name.  
 'P' terminal is available in 5.5 to 7.5kW inverters. 'P1' and 'P2' are available in 11 to 75kW inverters.  
 'B1' and 'B2' terminals are for braking resistor or connection. 'P1' and 'P2' are for braking unit.
- Analog speed command can be set by voltage, current and both of them.
- When installing the DC Reactor, the common busbar between P1 and P2 must be removed.
- 0.75 ~ 7.5kW inverters have on-board braking circuit. Braking resistor is only included for 0.75 ~ 3.7kW inverters.  
 11 ~ 75kW inverters need optional braking unit and resistor for dynamic braking.
- Marked as "CM" for over 30kW drives.



## Power terminal configuration

Symbol	Function
<b>R</b> <b>S</b> <b>T</b> <b>U</b> <b>V</b> <b>W</b>	AC Line input (3 phase, 200~230 Vac for "-2" units and 380~480 Vac for "-4" units)  3 phase output terminals to motor
<b>P</b>	Positive DC Bus Terminals, DC Bus Choke (reactor)connection terminals. These terminals are available for 5.5 to 7.5kW inverter with optional DB unit when an application need braking torque over 30% ED
<b>P1</b> <b>P2</b>	Positive DC Bus Terminals, DC Bus Choke (reactor)connection terminals. These terminals are available for 11 to 22kW inverter with optional DB unit. These terminal are shorted when DB unit is not applied.
<b>B1</b> <b>B2</b>	Dynamic braking resistor connection terminals. These terminals are available for 0.75 to 3.7kW inverters in order to connect an external braking resistor.
<b>N</b>	Negative DC Bus terminal
<b>G</b>	Chassis ground (The ground terminal ("G") may be located on heat sink instead of terminal strip depend on the model type)

## Control terminal configuration

Type	Symbol	Name	Description
Input signal	<b>Starting Contact</b>	<b>P1, P2, P3</b>	Multi function input 1,2,3 Used for multi function input. Factory default is set to step frequency 1, 2, 3.
	<b>Function Selection</b>	<b>FX</b>	Forward run command Forward run when closed and stop when open.
		<b>RX</b>	Reverse run command Reverse run when closed and stop when open.
		<b>JOG</b>	Jog frequency reference Runs at jog frequency when the jog signal is ON. The direction is set by the FX (or BX) signal.
		<b>BX</b>	Emergency stop When the BX signal is ON, the output of the inverter is cut off. When the motor uses an electrical brake to stop, BX is used to cut off the output signal. When the BX signal, which does not cut off by latching, is OFF and the FX signal (or the RX signal) is ON, the motor keeps running, so be cautious.
		<b>RST</b>	Fault reset Used to release the protective status when the protective circuit is active.
	Analog/Digital	<b>CM</b>	Sequence common Used for the common terminal for contact input terminals.
		<b>NC</b>	- Not used.
		<b>VR</b>	Frequency setting power (+12V) Used as power for the analog frequency setting. Maximum output is +12V, 100mA.
		<b>V1</b>	Frequency reference (Voltage) Used for frequency reference and uses 0-10V for input. Input resistance is 20 kΩ
<b>I</b>		Frequency reference (Current) Used for frequency reference and uses DC 4-20mA for input. Input resistance is 250Ω	
	<b>5G</b>	Frequency setting common terminal Common terminal for the analog frequency reference signal and the FM (for monitoring).	
Output signal	<b>Pulse</b>	<b>FM</b>	Analog/digital output (For external monitoring) Outputs one of the followings: output frequency, output current, output voltage, DC link voltage. Factory default is set to output frequency. Maximum output voltage and output current is 0-12V, 1mA. Output frequency is set to 500Hz.
	<b>Contact</b>	<b>30A,30C,30B</b>	Fault contact output Activates when the protective function is operating. AC250V 1A or less, DC30V 1A or less Fault : 30A-30C short (30B-30C open) Normal : 30B-30C short (30A-30C open)
		<b>AXA,AXC</b>	Multi-function output Use after defining the multi-function output terminal. AC250V 1A or less, DC30V 1A or less.
Comm.	<b>RS232</b>	<b>CN3</b>	Communication port Use the keypad connector. Use the keypad connector for RS232 communication. Disconnect the keypad and connect the RS232-RS485 converter for RS485 communication.

## Keypad

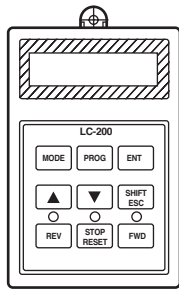

### 1. LCD Keypad

Key/LED	Name	Description
<b>MODE</b>	Mode key	The mode button moves you through the seven program groups : DRV, FUN1, FUN2, I/O, (EXT), (COM) and APP.
<b>PROG</b>	Program key	The program button is used to go into programming mode to change data.
<b>ENT</b>	Enter key	The enter button is used to enter changed parameters.
<b>▲</b>	UP	Up key
<b>▼</b>	DOWN	Down key
	<b>SHIFT/ESC</b>	Shift key The button is used to move cursor across the display in a programming mode.
	<b>REW</b>	Reverse key This button is used to move the program code to DRV00 from any program code.
	<b>STOP/RESET</b>	Stop key The stop button is used to the drive from running. Reset key The reset button is used to reset faults.
	<b>FWD</b>	Forward key The forward run button is used to run the motor in forward direction.
	<b>REV</b>	Reverse run The LED blinks when th inverter accels or decels.
	<b>STOP/RESET</b>	Stop/reset The LED blinks when there is a fault.
	<b>FWD</b>	Forward run The LED blinks when the inverter accels or decels.

### 2. LED Keypad (7-segment)

<b>Encoder knob</b>	Encoder Knob	This is used to move you through seven parameter groups and parameter codes. Also, used to change data by rotating knob.
	<b>SET</b>	Set key This is used to go into program mode to change data and to enter the changed data.
	<b>SHIFT/ESC</b>	Shift key This is used to go into program mode to change data and to enter the changed data. Escape key This button is used to move cursor across the display in a programming mode.
	<b>STOP/RESET</b>	Stop key This is used to stop the inverter from running. The reset button is used to reset faults. Reset key This is used to run the inverter.
	<b>RUN</b>	Run key The motor direction is set in DRV13.
	<b>SET</b>	Setting status It blinks in setting mode.
	<b>STOP/RESET</b>	Stop/Fault status The LED is lit in Stop status and blinks in fault status.
	<b>RUN</b>	Run status The LED is lit in Run status and blinks in fault status.
	<b>DRV</b>	Drive group It blinks in drive group.
	<b>FU1</b>	Function1 group It blinks in Function1 group.
	<b>FU2</b>	Function2 group It blinks in Function2 group.
	<b>I/O</b>	I/O group It blinks in I/O group.
	<b>EXT</b>	Sub-board group It blinks in Sub-board group.
	<b>I/O+EXT</b>	Option-board group It blinks in Option board group.
	<b>I/O+EXT+FU2</b>	Application group It blinks in Application group.

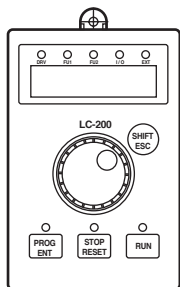

## Parameter group

Parameter group	LCD keypad	7-segment keypad	Description
Drive	DRV	DRV LED is lit	Command frequency, accel/decel time, etc. Basic parameters.
Function 1	FU1	FU1 is lit	Max. frequency, amount of torque boost, etc. Basic function related parameters.
Function 2	FUN2	FU2 is lit	Frequency jumps, max./min. limit of frequency etc. Application function related parameters.
Input / Output	I/O	I/O is lit	Multi function terminal setting, auto operation etc. Parameter needed for sequence operation.
External board	EXT	EXT is lit	Displayed when sub-board is installed.
Communication	COM	I/O + EXT are lit	Displayed when option board is installed.
Application	APP	I/O + EXT + FU2 are lit	Specific application related parameters.

## Parameter navigation

### 1. LCD Keypad

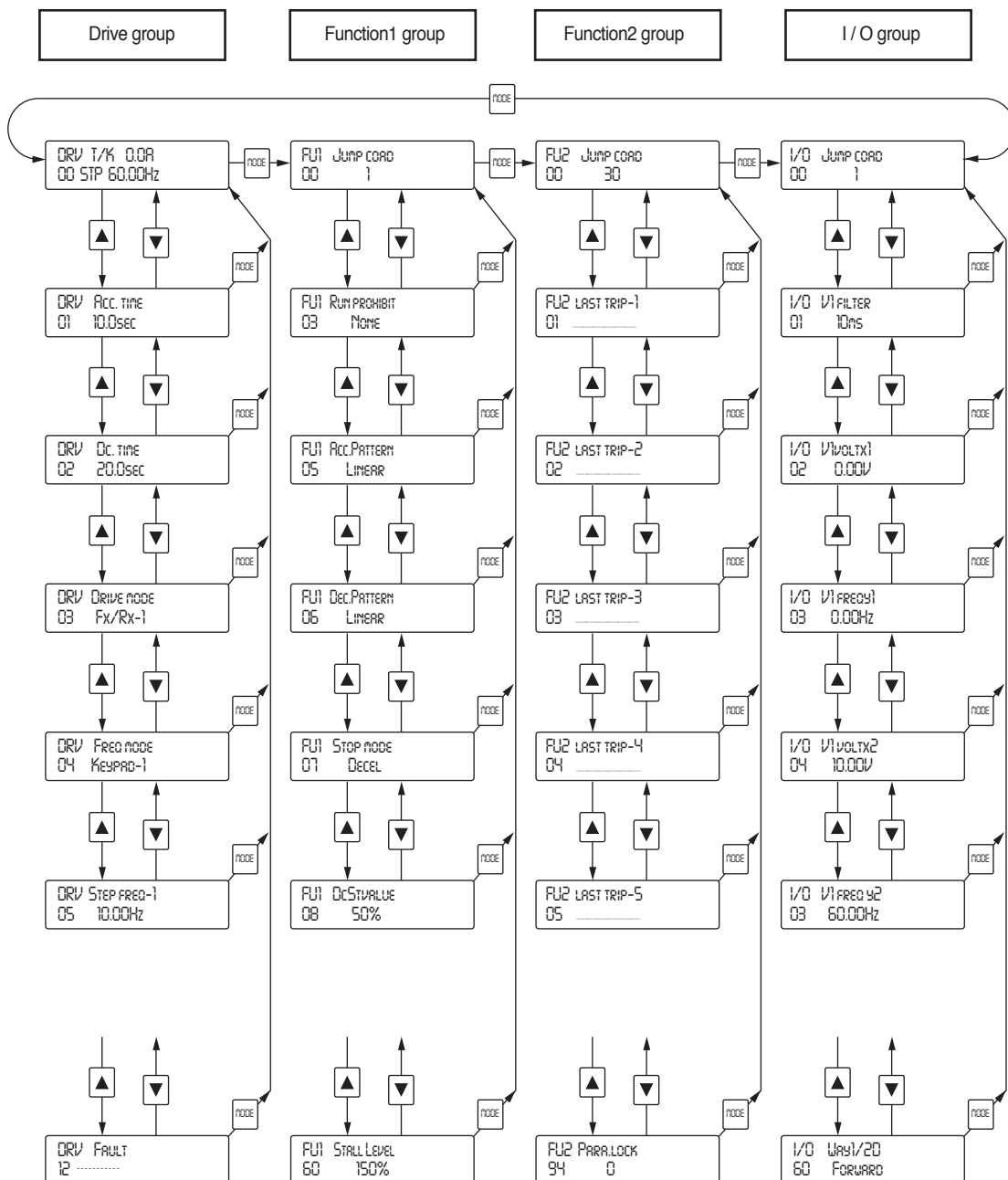



## Program parameter descriptions

### 1. Drive Group [DRV]

Code	Description	Keypad Display		Setting Range		Units	Factory Default	Adjustable during run
		LCD	7-segment	LCD	7-segment			
<b>DRV-00</b>	Output Frequency or Reference Frequency. Output Current (LCD)	Cmd.freq	F or r (DRV-13)	0 to FU1-20 (Max.freq)		0.01	0.00 [Hz]	Yes
<b>DRV-01</b>	Acceleration Time	Acc.time	01	0 to 6000		0.1	10.0 [sec]	Yes
<b>DRV-02</b>	Deceleration Time	Dec.time	02	0 to 6000		0.1	20.0 [sec]	Yes
<b>DRV-03</b>	Drive Mode (Run/Stop method)	Drive mode	03	Keypad Fx/Rx-1 Fx/Rx-2	0 1 2	1	1 (Fx/Rx-1)	No
<b>DRV-04</b>	Frequency Mode (Freq. setting method)	Freq mode	04	Keypad-1 Keypad-2 V1 1 V1+1	0 1 2 3 4	1	0 (keypad-1)	No
<b>DRV-05</b>	Step Frequency 1	Step freq-1	05	FU1-22 to Fu1-20		0.01	10.00 [Hz]	Yes
<b>DRV-06</b>	Step Frequency 2	Step freq-2	06	(Starting freq to Max. freq)		-	20.00 [Hz]	-
<b>DRV-07</b>	Step Frequency 3	Step freq-3	07	The load current in RMS		-	30.00 [Hz]	-
<b>DRV-08</b>	Output Current	Current	08	The motor speed in rpm		-	# [A]	-
<b>DRV-09</b>	Motor Speed	Speed	09	The DC link voltage inside inverter		-	# [rpm]	-
<b>DRV-10</b>	DC link Voltage	DC link Vtg	10	Selected in FU-73 (User disp)		-	# [V]	-
<b>DRV-11</b>	User Display selection	User disp	11	-		-	-	Yes
<b>DRV-12</b>	Fault Display	Fault	12	Not available	0 [Forward] 1 [reverse]	-	None nOn	-
<b>DRV-13</b>	Motor Direction set	Not displayed	13			-	0	-
<b>DRV-14</b>	Command/output frequency	Tar/Out Freq.	14	Command/output frequency		-	# [Hz]	Yes
<b>DRV-15</b>	Command/feedback frequency	Ref/Fdb Freq.	15	Command/feedback frequency		-	# [Hz]	Yes
<b>DRV-20</b>	FU1 Group selection	Not displayed	20	Not available	Press	-	1	Yes
<b>DRV-21</b>	FU2 Group selection		21		[Prog/ENT] key	-	1	Yes
<b>DRV-22</b>	I/O Group selection		22			-	1	Yes
<b>DRV-23</b>	EXT Group selection		23			-	1	Yes
<b>DRV-24</b>	COM Group selection		24			-	1	Yes
<b>DRV-25</b>	APP Group selection		25			-	1	Yes

### 2. Function 1 Group [FU1]

<b>FU1-00</b>	aJump to desired code #	Jump code	Not displayed	1 to 99	Not available	1	1	Yes
<b>FU1-03</b>	Run Prevention	Run Prev.	3	None Forward Prve Reverse Prve	0 1 2	1	0 (None)	No
<b>FU1-05</b>	Acceleration Pattern	Acc.pattern	5	Liner S-curve U-curve Minimum Optimum	0 1 2 3 4	1	0 (Liner)	No
<b>FU1-06</b>	Deceleration Pattern	Dec.pattern	6	Liner S-curve U-curve Minimum Optimum	0 1 2 3 4	1	0 (Liner)	No
<b>FU1-07</b> [1]	Stop Mode	Stop mode	7	Decel DC-brake Free-run	0 1 2	1	0 (Decel)	No
<b>FU1-08</b>	DC Injection Braking Frequency	DCBr freq	8	FU1-22 to 60 [Hz]		0.01	5.00 [Hz]	No
<b>FU1-09</b>	DC Injection Braking On-delay	DCBlk time	9	0 to 60 [sec]		0.01	0.1 [sec]	No
<b>FU1-10</b>	DC Injection Braking Voltage	Dcbr value	10	0 to 200 [sec]		1	50 [%]	No
<b>FU1-11</b>	DC Injection Braking Time	DcBr time	11	0 to 60 [sec]		0.1	1.0 [sec]	No
<b>FU1-12</b>	StartingDC Injection Braking Voltage	DcSt value	12	0 to 200 [sec]		1	50 [%]	No
<b>FU1-13</b>	StartingDC Injection Braking Time	DcSt time	13	0 to 60 [sec]		0.1	0.0 [sec]	No
<b>FU1-20</b>	Maximum Frequency	Max freq	20	40 to 400[Hz]		0.01	60.00 [Hz]	No
<b>FU1-21</b>	Base Frequency	Base freq	21	30 to FU1-20		0.01	60.00 [Hz]	No
<b>FU1-22</b>	Starting Frequency	Start freq	22	0.01 to 10[Hz]		0.01	0.50 [Hz]	No
<b>FU123</b> [2]	Frequency Limit selection	Freq limit	23	No Yes	0 1	1	0 (No)	No
<b>FU1-24</b>	Low Limit Frequency	F-limit Lo	24	FU1-22 to Fu1-25		0.01	0.50[Hz]	No
<b>FU1-25</b>	High Limit Frequency	F-limit Hi	25	FU1-22 to Fu1-25		0.01	60.00[Hz]	No
<b>FU1-26</b>	Manual/Auto Torque Boost selection	Torque booth	26	Manual Auto	0 1	1	0 (Manual)	No
<b>FU1-27</b>	Torque Boost in Forward Direction	Fwd booth	27	0 to 15 [%]		0.01	2.0 [%]	No
<b>FU1-28</b>	Torque Boost in Reverse Direction	Rev booth	28	0 to 15 [%]		1	2.0 [%]	No
<b>FU1-29</b> [3]	Volts/Hz Pattern	V/F pattern	29	Linear Square User V/F	0 1 2	0.01	0 (Linear)	No
<b>FU1-30</b>	User V/F - Frequency 1	User freq 1	30	0 to FU1-20		0.01	15 [Hz]	No
<b>FU1-31</b>	User V/F - Voltage 1	User volt 1	31	0 to 100 [%]		1	25 [%]	No
<b>FU1-32</b>	User V/F - Frequency 2	User freq 2	32	0 to FU1-20		0.01	30.00 [Hz]	No
<b>FU1-33</b>	User V/F - Voltage 2	User volt 2	33	0 to 100 [%]		1	50 [%]	No
<b>FU1-34</b>	User V/F - Frequency 3	User freq 3	34	0 to FU1-20			45 [Hz]	No
<b>FU1-35</b>	User V/F - Voltage 3	User volt 3	35	0 to 100 [%]			75 [%]	No
<b>FU1-36</b>	User V/F - Frequency 4	User freq 4	36	0 to FU1-20			60.00 [Hz]	No
<b>FU1-37</b>	User V/F - Voltage 4	User volt 4	37	0 to 100 [%]			100 [%]	No
<b>FU1-38</b>	Output Voltage Adjustment	Volt control	38	40 to 110.0 [%]			100.0 [%]	No
<b>FU1-39</b>	Energy Save Level F39	Energy save	39	0 to 30 [%]			0 [%]	Yes
<b>FU150</b> [4]	Electronic Thermal selection	ETH select	50	No Yes	0 1		0 (No)	Yes

## 2. Function 1 Group [FU1]

Code	Description	Keypad Display		Setting Range		Units	Factory Default	Adjustable during run
		LCD	7-segment	LCD	7-segment			
<b>FU1-51</b>	Electronic Thermal Level for 1 minute	ETH 1min	5 1	FU1-52 to 200 [%]		1	150 [%]	Yes
<b>FU1-52</b>	Electronic Thermal Level for continuous	ETH cont	52	50 to FU1-51		1	100 [%]	Yes
<b>FU1-53</b>	Electronic Thermal Characteristic selection	Motor type	53	self-cool	0	1	0 (self-cool)	Yes
<b>FU1-54</b>	(Motor type)			Forced-coo	1			
<b>FU1-55</b>	Overload Warning Level	OL level	54	30 to 150 [%]		1	150 [%]	Yes
<b>FU1-56</b>	Overload Warning Hold Time	OL time	55	0 to 30 [sec]		0.1	10.0 [sec]	Yes
	Overload Trip selection	OLT select	56	No	0	1	1 (Yes)	Yes
<b>FU1-57</b>				Yes	1			
<b>FU1-58</b>	Overload Trip Level	OLT level	57	30 to 150 [%]		1	180 [%]	Yes
<b>FU1-59</b>	Overload Trip Delay Time	OLT time	58	0 to 60 [sec]		1	60.0 [sec]	Yes
<b>FU1-60</b>	Stall Prevention Mode selection	Stall prev.	59	000 to 111 (bit set)		bit	000	No
<b>FU1-99</b>	Stall Prevention Level	Stall level	60	30 to 150 [%]		1	150 [%]	No
	Return Code	Not display	99	Not available	[PROG/ENT] or [SHIFT/ESC]	1	1	Yes

## 3. Function 2Group [FU2]

Code	Description	Keypad Display		Setting Range		Units	Factory Default	Adjustable during run
		LCD	7-segment	LCD	7-segment			
<b>FU2-00</b>	Jump to desired code #	Jump code	Not displayed	1 to 99	Not available	1	30	Yes
<b>FU2-01</b>	Previous Fault History 1	Last trip-1	1				0 (None)	
<b>FU2-02</b>	Previous Fault History 2	Last trip-2	2					
<b>FU2-03</b>	Previous Fault History 3	Last trip-3	3					
<b>FU2-04</b>	Previous Fault History 4	Last trip-4	4					
<b>FU2-05</b>	Previous Fault History 5	Last trip-5	5					
<b>FU2-06</b>	Erase Fault History	Erase trips	6	No	0	1	0 (No)	Yes
				Yes	1			
<b>FU2-07</b>	Dwell Frequency	Dwell freq	7	FU1-22 to FU1-20		0.01	5.00 [Hz]	No
				(starting freq.to Max.freq.)				
<b>FU2-08</b>	Dwell Time	Dwell time	8	0 to 10 [sec]		0.1	0.0 [sec]	No
<b>FU2-10</b> [5]	Frequency Jump selection	Jump Freq	10	No	0	1	0 (No)	No
				Yes	1			
<b>FU2-11</b>	Jump Frequency 1 Low	Jump lo 1	1 1	Fu1-22 to FU2-12		0.01	10.00 [Hz]	No
<b>FU2-12</b>	Jump Frequency 1 High	Jump Hi 1	1 2	Fu1-11 to FU2-20		0.01	15.00 [Hz]	No
<b>FU2-13</b>	Jump Frequency 2 Low	Jump lo 2	1 3	Fu1-22 to FU2-14		0.01	20.00 [Hz]	No
<b>FU2-14</b>	Jump Frequency 2 High	Jump Hi 2	1 4	Fu1-13 to FU2-20		0.01	25.00 [Hz]	No
<b>FU2-15</b>	Jump Frequency 3 Low	Jump lo 3	1 5	Fu1-22 to FU2-16		0.01	30.00 [Hz]	No
<b>FU2-16</b>	Jump Frequency 3 High	Jump Hi 3	1 6	Fu1-15 to FU2-20		0.01	35.00 [Hz]	No
<b>FU2-17</b>	Starting rate of S curve	Start Curve	1 9	0 - 100 [%]		1	40 [%]	No
<b>FU2-18</b>	Ending rate of curve	End curve	1 9	0 - 100 [%]		1	40 [%]	No
<b>FU2-19</b>	Input/Output Phase Loss Protection	Trip select	1 9	00 to 11 (bit set)		-	00	Yes
<b>FU2-20</b>	Power ON Start selection	Power-on run	20	No	0	1	0 (No)	Yes
				Yes	1			
<b>FU2-21</b>	Restart after Fault Reset	RST restart	2 1	No	0		0 (No)	Yes
				Yes	1			
<b>FU2-22</b>	Speed Search selection	Speed Search	22	0000 to 1111 (bit set)		-	0000	No
<b>FU2-23</b>	Current Limit Level during Speed Search	SS Sup-Curr	23	80 to 200 [%]		1	100 [%]	Yes
<b>FU2-24</b>	P Gain during Speed Search	SS P-gain	24	0 to 30000		1	100	Yes
<b>FU2-25</b>	I Gain during speed search	SS I-gain/Retry	25	0 to 30000		1	1000	Yes
<b>FU2-26</b>	Number of Auto Restart Attempt	number	26	0 to 10		1	0	Yes
<b>FU2-27</b>	Delay Time before Auto Restart	Retry Delay	27	0 to 60 [sec]		0.1	1.0 [sec]	Yes
<b>FU2-30</b>	Rated Motor selection	Motor select	30	0.75kW	0	1	[6]	No
				1.5kW	1			
				2.2kW	2			
				3.7kW	3			
				5.5kW	4			
				7.5kW	5			
				11.0kW	6			
				15.0kW	7			
				18.5kW	8			
				22.0kW	9			
				30kW	10			
				37kW	11			
				45kW	12			
				55kW	13			
				75kW	14			
<b>FU2-31</b>	Number of Motor Pole	Pole number	3 1	2 to 12		1	4	No
<b>FU2-32</b>	Rated Motor Slip	Rated-Slip	32	0 to 10 [Hz]		0.01	[7]	No
<b>FU2-33</b>	Rated Motor Current in RMS	Rated-Curr	33	1 to 200 [A]		1		No
<b>FU2-34</b>	No Load Motor Current in RMS	Noload-	34	0.5 to 200 [A]		1		No
<b>FU2-36</b>	Motor Efficiency	CurrEfficiency	36	70 to 100 [%]		1		No
<b>FU2-37</b>	Load Inertia	Inertia rate	37	0 to 1		1	0	No
<b>FU2-38</b>	Carrier Frequency	Carrier freq	38	[8] 1 to 15 [kHz]		1	5 [kHz]	Yes
<b>FU2-39</b>	Control Mode selection	Control mode	40	V/F	0	1	0 [V/F]	No
				Slip comp	1			
				PID	2			
				Sensorless	3			
<b>FU2-40</b>	Auto tuning selection	Auto tuning	4 1	No	0	1	0 (No)	No
				Yes	1			

3. Function 2Group [FU2]

Code	Description	Keypad Display		Setting Range		Units	Factory Default	Adjustable during run
		LCD	7-segment	LCD	7-segment			
<b>FU2-41</b>	Stator resistance	Rs	41	Decided depending on motor capacity		0.001	Decided depending on motor capacity	No
<b>FU2-42</b>	Leakage inductance	Lsigma	42	Decided depending on motor capacity		0.001	Decided depending on motor capacity	No
<b>FU2-43</b>	Stator inductance	Ls	43	Decided depending on motor capacity		0.001	Decided depending on motor capacity	No
<b>FU2-44</b>	Rotor time constant	Tr	44	Decided depending on motor capacity		1	Decided depending on motor capacity	Yes
<b>FU2-45</b>	P gain for sensorless mode	SL P-gain	45	0 to 3276		1	1000	Yes
<b>FU2-46</b>	I gain for sensorless mode	SL I-gain	46	0 to 3276		1	1000	No
<b>FU2-47</b>	PID operation selection	Proc PI mode	47	0 (No) 1 (Yes)		1	0	No
<b>FU2-48</b>	PID feed forward gain	PID F- gain	48	0-999.9[%]		0.1[%]	0.0[%]	Yes
<b>FU2-49</b>	PID Reference mode selection	PID Ref	49	Freq. Mode	0	1	0 (Freq mode)	No
				Keypad-1	1			
				Keypad-2	2			
				V1	3			
				I	4			
				V1+I	5			
<b>FU2-50</b>	PID Output direction selection	PID Ref Mode	50	Ramp freq	0	1	0 (Ramp freq)	No
				Target freq	1	1		
<b>FU2-51</b> [10]	PID feedback Signal selection	PID F/B	51	I	0	1	0 (I)	No
				V1	1			
				V2	2			
<b>FU2-52</b>	P Gain for PID Control	PID P-gain	52	0 to 999.9 [%]		1	300.0 [%]	Yes
<b>FU2-53</b>	I Gain for PID Control	PID I-gain	53	0to 32.0 [sec]		1	30.0 [sec]	Yes
<b>FU2-54</b>	D Gain for PID Control	PID D-gain	54	0 to 999.9 [msec]		0.01	0 (No)	Yes
<b>FU2-55</b>	Limit (+) Frequency for PID Control	PID+limit	55	0 to FU1-20		0.01	60.00 [Hz]	Yes
<b>FU2-56</b>	Limit (-) Frequency for PID Control	PID-limit	56	0 to FU1-20		1	60.00 [Hz]	No
<b>FU2-57</b>	PID Output inverter	PID Out Inv.	57	No	0	0.1 [%]	0 (No)	No
				Yes	1			
<b>FU2-58</b>	PID Output gain scale	PID Out Scale	58	0.1 to 999.9 [%]		0.1 [%]	100.0 [%]	No
<b>FU2-59</b>	PID P2 scale	PID P2-gain	59	0.0 to 999.9 [%]		0.1 [%]	100.0 [%]	No
<b>FU2-60</b>	P gain scale	P-gain Scale	60	0.0 to 100 [%]		1	100.0 [%]	Yes
<b>FU2-69</b>	Speed Acc/dec turning point		69					
<b>FU2-70</b>	Reference Frequency for Accel and Decel	Acc/Dec freq	70	Max freq	0	1	0 (Max.frq)	Yes
				Delta freq	1			
<b>FU2-71</b>	Accel/Decel Time scale	Time scale	71	0.01 [sec]	0	1	0 (0.01[sec])	Yes
				0.1 [sec]	1			
				1 [sec]	2			
<b>FU2-72</b>	Power On Display	PowerOn disp	72	0 to 12		1	0	Yes
<b>FU2-73</b>	User Display selection	User disp	73	Voltage	0	1	0 (Voltage)	
				Watt	1			
				Torque	2			
<b>FU2-74</b>	Gain for Motor Speed Display	RPM factor	74	1 to 1000 [%]		1	100 [%]	Yes
<b>FU2-75</b>	DB (Dynamic Braking) Resistor Mode selection	DB mode	75	None	0	1	1 (Int.DB-R)	Yes
				Int. DB-R	1			
				Ext. DB-R	2			
<b>FU2-76</b> [11]	Duty of Dynamic Braking Resistor	DB %ED	76	0 to 30 [%]			10 [%]	-
<b>FU2-79</b>	Software Version	S/W version	79	ver.1.05		-0.1	Ver.1.05	Yes
<b>FU2-81</b> [12]	2 <sup>nd</sup> Acceleration Time	2nd Acc time	81	0 to 6000 [sec]		0.1	5.0 [sec]	Yes
<b>FU2-82</b>	2 <sup>nd</sup> Deceleration Time	2nd Dec time	82	0 to 6000 [sec]		0.01	10.0 [sec]	No
<b>FU2-83</b>	2 <sup>nd</sup> Base Frequency	2nd Basefreq	83	30 to FU1-20		1	60.0 [Hz]	No
<b>FU2-84</b>	2 <sup>nd</sup> Pattern	2nd V/F	84	Liner	0	0.1	0 (Liner)	No
				Square	1			
				User V/F	2			
<b>FU2-85</b>	2 <sup>nd</sup> Forward Torque Boost	2nd F-boost	85	0 to 15 [%]		0.1	2.0 [%]	No
<b>FU2-86</b>	2 <sup>nd</sup> Reverse Torque Boost	2nd R-boost	86	0 to 15 [%]		1	2.0 [%]	No
<b>FU2-87</b>	2 <sup>nd</sup> Stall Prevention Level	2nd Stall	87	30 to 150 [%]		1	150 [%]	Yes
<b>FU2-88</b>	2 <sup>nd</sup> Electronic Thermal Level for 1 minute	2nd ETH 1min	88	FU2-89 to 200 [%]		1	150 [%]	Yes
<b>FU2-89</b>	2 <sup>nd</sup> Electronic Thermal Level for continuous	2ndETH cont	89	50 to FU2-88 (maximum150%)		0.1	100 [%]	No
<b>FU2-90</b>	2 <sup>nd</sup> Rated Motor Current	2nd R-Curr	90	1 to 200 [A]		1	3.6 [A]	No
<b>FU2-91</b>	Read Parameters into Keypad from inverter	Para. Read	91	No	0	1	0 (No)	No
				Yes	1			
<b>FU2-92</b>	Write Parameter to inverter from Keypad	Para. Write	92	No	0	1	0 (No)	No
				Yes	1			
<b>FU2-93</b>	Initialize Parameter	Para. Init	93	No	0	1	0 (No)	Yes
				All group	1			
				DRV	2			
				FU1	3			
				FU2	4			
				I/O	5			
				EXT	6			
<b>FU2-94</b>	Parameter Write Protection	Para. Lock	94	0 to 255		1	0	Yes
<b>FU2-99</b>	Return Code	Not display	99	Not available		-	1	Yes
				[PROG/ENT] or [SHIFT/ESC]				

4. Input / Output [I/O]

Code	Description	Keypad Display		Setting Range		Units	Factory Default	Adjustable during run
		LCD	7-segment	LCD	7-segment			
<b>I/O-00</b>	Jump to desired code#	Jump	Not Displayed	1 to 99	Not available	1	1	Yes
<b>I/O-01</b>	Filtering Time Constant for V1 Signal Input	V1 Filter	I	0 to 9999 [ms]		1	10 [ms]	Yes
<b>I/O-02</b>	V1 Input Minimum Voltage	V1 volt x1	2	0 to 10 [V]		0.01	0.00 [V]	Yes
<b>I/O-03</b>	Frequency corresponding to V1 Input Minimum Voltage	V1 freq y1	3	0 to FU1-20 (Max.freq)		0.01	0.00 [Hz]	Yes
<b>I/O-04</b>	V1 Input Maximum Voltage	V1 volt x2	4	0 to 10 [V]		0.01	10.00 [V]	Yes
<b>I/O-05</b>	Frequency corresponding to V1 Input Minimum Voltage	V1 freq y2	5	0 to FU1-20 (Max.freq)		0.01	60.00 [Hz]	Yes

## 4. Input / Output [I/O]

Code	Description	Keypad Display		Setting Range		Units	Factory Default	Adjustable during run
		LCD	7-segment	LCD	7-segment			
I/O-06	Filtering Time Constant for V1 Signal Input	I filter	6	0 to 9999 [ms]		1	10 [ms]	Yes
I/O-07	Input Minimum Current	V1 curr x1	7	0 to20 [ms]		0.01	4.00 [mA]	Yes
I/O-08	Frequency corresponding to V1 Input Minimum Voltage	V1 freq y1	8	0 to FU1-20 (Max.freq)		0.01	0.00 [Hz]	Yes
I/O-09	I Input Minimum Current	V1 curr x2	9	0 to20 [ms]		0.01	20.00 [mA]	Yes
I/O-10	Frequency corresponding to I Input Maximum Current	I freq y2	10	0 to FU1-20		0.01	60.00 [Hz]	Yes
I/O-11	Criteria for Analog Input Signal Loss	Wire broken	11	None	0	1	0 (None)	Yes
I/O-12	Multi-function Input Terminal `P1`define	P1 define	12	below x1	1	1	0 (Speed-L)	Yes
				Speed -L	0			
				Speed -M	1			
				Speed -H	2			
				XCEL-L	3			
				XCEL-M	4			
				XCEL-H	5			
				Dc-brake	6			
				2nd Func	7			
				Exchange	8			
				-Reverse-	9			
				Up	10			
				Down	11			
				3-Wire	12			
				Ext Trip-A	13			
				Ext Trip-B	14			
				-Reverse-	15			
				Open-loop	16			
				Main-Drive	17			
				Analog hold	18			
				XCEL stop	19			
				-Reverse-	20			
				SEQ-L	21			
				SEQ-M	22			
SEQ-H	23							
Manual	24							
Go step	25							
Hold stepTrv	26							
Off. Lo	27							
Trv Off. Hi	28							
Interlock1	29							
Interlock2	30							
Interlock3	31							
Interlock4	32							
I/O-13	Multi-function Input Terminal `P2`define	P2 define	13	Same as above		1	1 (Speed-M)	Yes
I/O-14	Multi-function Input Terminal `P3`define	P3 define	14	Same as above		1	2 (Speed-H)	Yes
I/O-15	Terminal Input Status	In status	15	000000000 to 11111111		-	000000000	-
I/O-16	Terminal Output Status	Out status	16	0000 to 1111		-	0000	-
I/O-17	Filtering Time Constant for Multi-function Input Terminal	Ti Fit Num	17	2 to 50		1	15	Yes
I/O-20	Jog Frequency setting	Jog freq	20	FU1-22 to FU1-20 (Starting freq to	0.01		10.00 [Hz]	Yes
I/O-21	Step Frequency 4	Step freq-4	21	Max, freq)			40.00 [Hz]	Yes
I/O-22	Step Frequency 5	Step freq-5	22				50.00 [Hz]	Yes
I/O-23	Step Frequency 6	Step freq-6	23				40.00 [Hz]	Yes
I/O-24	Step Frequency 7	Step freq-7	24				30.00 [Hz]	Yes
I/O-25	Acceleration Time 1 for Step Frequency	Acc time-1	25	0 to 6000 [sec]		0.1	20.0 [sec]	Yes
I/O-26	Deceleration Time 1 for Step Frequency	Dec time-1	26	0 to 6000 [sec]		0.1	20.0 [sec]	Yes
I/O-27	Acceleration Time 2	Acc time-2	27	0 to 6000 [sec]		0.1	30.0 [sec]	Yes
I/O-28	Deceleration Time 2	Dec time-2	28	0 to 6000 [sec]		0.1	30.0 [sec]	Yes
I/O-29	Acceleration Time 3	Acc time-3	29	0 to 6000 [sec]		0.1	40.0 [sec]	Yes
I/O-30	Deceleration Time 3	Dec time-3	30	0 to 6000 [sec]		0.1	40.0 [sec]	Yes
I/O-31	Acceleration Time 4	Acc time-4	31	0 to 6000 [sec]		0.1	50.0 [sec]	Yes
I/O-32	Deceleration Time 4	Dec time-4	32	0 to 6000 [sec]		0.1	50.0 [sec]	Yes
I/O-33	Acceleration Time 5	Acc time-5	33	0 to 6000 [sec]		0.1	40.0 [sec]	Yes
I/O-34	Deceleration Time 5	Dec time-5	34	0 to 6000 [sec]		0.1	40.0 [sec]	Yes
I/O-35	Acceleration Time 6	Acc time-6	35	0 to 6000 [sec]		0.1	30.0 [sec]	Yes
I/O-36	Deceleration Time 6	Dec time-6	36	0 to 6000 [sec]		0.1	30.0 [sec]	Yes
I/O-37	Acceleration Time 7	Acc time-7	37	0 to 6000 [sec]		0.1	20.0 [sec]	Yes
I/O-38	Deceleration Time 7	Dec time-7	38	0 to 6000 [sec]		0.1	20.0 [sec]	Yes
I/O-40	FM (Frequency Meter) Output selection	FM mode	40	Frequency	0	1	0 (Frequency)	Yes
				Current	1			
				Voltage	2			
				DC link voltage	3			
I/O-41	FM Output Adjustment	FM adjust	41	10 to 200 [%]		1	100 [%]	Yes
I/O-42	Frequency Detection Level	FDT freq	42	0 to FU1-20		0.01	30.00 [Hz]	Yes
I/O-43	Frequency Detection Bandwidth	FDT band	43	0 to FU1-20		0.01	10.00 [Hz]	Yes
I/O-44	Multi-function Auxiliary Contact Output define(AXA, AXC)	Aux mode	44	FDT-1	0	1	12 (run)	Yes
				FDT-2	1			
				FDT-3	2			
				FDT-4	3			
				FDT-5	4			
				OL	5			
				IOL	6			
				Stall	7			
OV	8							

### 4. Input / Output [I/O]

Code	Description	Keypad Display		Setting Range		Units	Factory Default	Adjustable during run
		LCD	7-segment	LCD	7-segment			
<b>I/O-44</b>				LV OH Lost Command Run Stop	9 10 11 12 13			
<b>I/O-45</b>	Fault Output Relay setting (30A,30B,30C)	Relay mode	45		000 to 111 (bit set)	-	010 [bit]	Yes
<b>I/O-46</b> [13]	Inverter Number	Inv No.	46		1 to 32	1	1	Yes
<b>I/O-47</b>	Baud Rate	Baud rate	47		1200bps 2400bps 4800bps 9600bps 19200bps	0 1 2 3 4	3 (9600bps)	Yes
<b>I/O-48</b>	Operation selection at loss of Freq. Reference	lost command	48		None Freerun Stop	0 1 2	0 (None)	Yes
<b>I/O-49</b>	Waiting Time after Loss of Freq. Reference	Time out	49		0.1 to 120[sec]	0.1	0.1 [sec]	Yes
<b>I/O-50</b>	Auto (Sequence)Operation selection	Auto mode	50		None Auto-A Auto-B	0 1 2		No
<b>I/O-51</b>	Sequence Number selection	Seq selet	51		1 to 5	1	0 (None)	Yes
<b>I/O-52</b>	The Number of steps of Sequence Number#	Step number	52		1 to 8	1	1	Yes
<b>I/O-53</b> [14]	1 <sup>st</sup> Step Frequency of Sequence	Seq1/1F	53		0.01 to FU1-20 (Max.freq.)	0.01	2	Yes
<b>I/O-54</b>	Transient Time to 1 <sup>st</sup> Step of Sequence	Seq1/1T	54		0.1 to 6000 [sec]	0.1	11.00 [Hz]	Yes
<b>I/O-55</b>	Steady Speed Time at 1 <sup>st</sup> Step of Sequence	Seq1/1S	55		0.1 to 6000 [sec]	0.1	1.1 [sec]	Yes
<b>I/O-56</b>	Motor Direction of 1 <sup>st</sup> Step of Sequence 1	Seq1/1D	56		Reverse Forward	0 1	1.1 [sec]	Yes
<b>I/O-57</b>	1 <sup>st</sup> Step of Frequency of Sequence 2	Seq1/1F	57		0.01 to FU1-20 (Max.freq.)	0.01	1 (Forward)	Yes
<b>I/O-58</b>	Transient Time to 1 <sup>st</sup> Step of Sequence 2	Seq1/1T	58		0.1 to 6000 [sec]	0.1	21.00 [Hz]	Yes
<b>I/O-59</b>	Steady Speed Time at 1 <sup>st</sup> Step of Sequence 2	Seq1/1S	59		0.1 to 6000 [sec]	0.1	1.1 [sec]	Yes
<b>I/O-60</b>	Motor Direction of 1 <sup>st</sup> Step of Sequence 2	Seq1/1D	60		Reverse Forward	0 1	1.1 [sec]	Yes
<b>I/O-99</b>	Return Code	Not Disp layed	99		Not available [PROG/ENT] or [SHIFT/ESC]	1	1 (Forward) 1	Yes

### 5. External Group [EXT]

EXT group appears only when the corresponding option boards are installed.

Code	Description	Keypad Display		Setting Range		Units	Factory Default	Adjustable during run	
		LCD	7-segment	LCD	7-segment				
<b>EXT-00</b>	Jump to desired code #	Jump code	Not displayed		0 to 99	1	1	Yes	
<b>EXT-01</b>	Sub board Type display		1		None SUB-A SUB-B SUB-C SUB-D SUB-E	0 1 2 3 4 5	0 (None)	Automatically set	
<b>EXT-02</b>	Multi-function Input Terminal `P4` define	Sub B/C	2		SUB-F SUB-G SUB-H Speed -L Speed -M Speed -H XCEL-L XCEL-M XCEL-H Dc-brake 2nd Func Exchange -Reversed- Up Down 3-Wire Ext Trip-A Ext Trip-B -Reversed- Open-loop Main-Drive Analog hold XCEL stop -Reversed- SEQ-L SEQ-M SEQ-H Manual Go step Hold step Trv Off. Lo Trv Off. Hi	6 7 8 0 1 2 3 4 5 6 7 8 9 10 11 12 13 14 15 16 17 18 19 20 21 22 23 24 25 26 27 28	1	3 (XCEL-L)	Yes



## 5. External Group [EXT]

EXT group appears only when the corresponding option boards are installed.

Code	Description	Keypad Display		Setting Range		Units	Factory Default	Adjustable during run
		LCD	7-segment	LCD	7-segment			
<b>EXT-02</b>				Interlock1	29			
				Interlock2	30			
				Interlock3	31			
				Interlock4	32			
<b>EXT-03</b>	Multi-function Input Terminal `P5` define	P5 define	3	Same as above			4 (XCEL-M)	Yes
<b>EXT-04</b>	Multi-function Input Terminal `P6` define	P6 define	4	Same as above			5 (XCEL-H)	Yes
<b>EXT-05</b>	V2 Mode selection	V2 mode	5	None	0	-	0 (None)	No
				Override	1			
				Reference	2			
<b>EXT-06</b>	Filtering Time Constant for V2 Signal Input	V2 filter	6	0 to 10000 [ms]		1	10 [ms]	Yes
<b>EXT-07</b>	V2 Input Minimum Voltage	V2 volt x1	7	0 to 10 [V]		0.01	0.00 [V]	Yes
<b>EXT-08</b>	Frequency corresponding to V2 Input Minimum Voltage	V2 freq y2	8	0 to FU1-20 (Max.freq.)		0.01	0.00 [Hz]	Yes
<b>EXT-09</b>	V2 Input Maximum Voltage	V2 volt x2	9	0 to 10 [V]		0.01	10.00 [V]	Yes
<b>EXT-10</b>	Frequency corresponding to V2 Input Maximum Voltage	V2 freq y2	10	0 to FU1-20 (Max.freq.)		0.01	60.00 [Hz]	Yes
<b>EXT-14</b>	Usage of Pulse Input Signal	F mode	14	None	0	-	0 (None)	No
				Fee-back	1			
				Reference	2			
<b>EXT-15</b>	Pulse Input Signal selection	F pulse set	15	A+B	0	-	0 (A+B)	Yes
				A	1			
<b>EXT-16</b>	Encoder Pulse Number	F pulse num	16	360 to 4096		1	1024	No
<b>EXT-17</b>	Filtering Time Constant for Pulse Input Signal	F filter	17	0 to 9999 [ms]		1	10 [ms]	Yes
<b>EXT-18</b>	Pulse Input Minimum Frequency	F pulse x1	18	0 to 100 [kHz]		0.01	0.00 [kHz]	Yes
<b>EXT-19</b>	Frequency Output corresponding to Pulse Input Minimum Frequency	F freq y1	19	0 to FU1-20 (Max.freq.)		0.01	0.00 [Hz]	Yes
<b>EXT-20</b>	Pulse Input Maximum Frequency	F pulse x2	20	0 to 100 [kHz]		0.01	10.00 [kHz]	Yes
<b>EXT-21</b>	Frequency Output corresponding to Pulse Input Maximum Frequency	F freq y2	21	0 to FU1-20 (Max.freq.)		0.01	60.00 [Hz]	Yes
<b>EXT-22</b>	P-Gain for `Sub-B`	PG P-gain	22	0 to 9999		1	3000	Yes
<b>EXT-23</b>	I-Gain for `Sub-B`	PG I-gain	23	0 to 9999		1	300	Yes
<b>EXT-24</b>	Slip P-Gain for Frequency `Sub-B` board	PG Slip freq	24	0 to 20[%]		1	100 [%]	Yes
<b>EXT-30</b>	Multi-function Output Terminal `Q1` define	Q1 define	30	FDT-1	0	-	0 (FDT-1)	Yes
				FDT-2	1			
				FDT-3	2			
				FDT-4	3			
				FDT-5	4			
				OL	5			
				IOL	6			
				Stall	7			
				OV	8			
				LV	9			
				OH	10			
				Lost Command	11			
				Run	12			
				Stop	13			
				Steady	14			
				INV line	15			
				COMM line	16			
				Search	17			
				Step pulse	18			
				Seq pulse	19			
				Ready	20			
				Trv. ACC	21			
				Trv. DEC	22			
				MMC	23			
<b>EXT-31</b>	Multi-function Output Terminal `Q2` define	Q2 define	31	Same as above		-	1 (FDT-2)	Yes
<b>EXT-32</b>	Multi-function Output Terminal `Q3` define	Q3 define	32	Same as above			2 (FDT-3)	Yes
<b>EXT-34</b>	LM (Load Meter)Output selection	LM mode	34	Frequency	0		1 (Current)	Yes
				Current	1			
				Voltage	2			
				DC link Vtg	3			
<b>EXT-35</b>	LM (Load Meter) Adjustment	LM adjust	35	100 to 200 [%]			100 [%]	Yes
<b>EXT-40</b>	AM1 (Analog Meter1)Output selection	AM1 mode	40	Frequency	0		0 (Frequency)	Yes
				Current	1			
				Voltage	2			
				DC link Vtg	3			
<b>EXT-41</b>	AM1 (Analog Meter1)Output Adjustment	AM1 adjust	41	100 to 200 [%]			100 [%]	Yes
<b>EXT-42</b>	AM2 (Analog Meter2)Output selection	AM2 mode	42	Frequency	0		3 (DC link Vtg)	Yes
				Current	1			
				Voltage	2			
				DC link Vtg	3			
<b>EXT-43</b>	AM2 (Analog Meter2)Output Adjustment	AM2 adjust	43	100 to 200[%]			100 [%]	Yes
<b>EXT-99</b>	Return Code	Not displayed	99	Not available	[PROG/ENT] or [SHIFT/ESC]		1	Yes

6. Communication Group [COM]

Code	Description	Keypad Display		Setting Range		Units	Factory Default	Adjustable during run
		LCD	7-segment	LCD	7-segment			
<b>COM-00</b>	Jump to desired code #	Jump code	Not Displayed	0 to 99	Not available	1	1	Yes
<b>COM-01</b>	Option board Type display	Opt B/D	1	None	0	1	0 (None)	Yes
				Device Net	1			
				Synchro	2			
				PLC-GF	3			
				Profibus-DP	4			
				Digital-in	5			
				RS485	6			
				Modbus-RTU	7			
<b>COM-02</b>	Option mode	Opt Mode	2	None	0	1	0 (None)	No
				Command	1			
				Frequency	2			
				Cmd+Freq	3			
<b>COM-03</b>	Option version	Opt Version	3	Option version				No
<b>COM-04</b>	Digital (Binary)option input mode selection	D-in Mode	4	8bit Bin	1	1	0 (8BitBin)	Yes
				8 BCD 1%	2			
				8 BCD 1Hz	3			
				12 Bit Bin	4			
				12 BCD 0.1%	5			
				12 BCD 0.1Hz	6			
				12 BCD 1Hz	7			
<b>COM-05</b>	Digital (Binary)input filter	Digital Ftr	5	0 to 50		1	15	Yes
<b>COM-10</b>	Device Net ID	MAC ID	10	0 to 63		1	0	Yes
<b>COM-11</b>	Device Net baud rate	Baud Rate	11	125kbps	0	1	0 (125 bps)	Yes
				250kbps	1			
				500kbps	2			
<b>COM-12</b>	Device Net output impedance	Out Instance	12	20	0	1	0 (20)	Yes
				21	1			
				100	2			
				101	3			
<b>COM-13</b>	Device Net input impedance	In Instance	13	70	0	1	0 (70)	Yes
				71	1			
				110	2			
				111	3			
<b>COM-17</b>	PLC station ID	Station ID	17	0 to 63		1	1	Yes
<b>COM-20</b>	Profibus-DP ID	Profi MAC ID	20	0 to 127		1	1	Yes
<b>COM-30</b>	Number of output	Output Num	30	0 to 8		1	3	Yes
<b>COM-31</b>	Output 1	Output 1	31	0000 to 57FF (HEX)		-	000A (HEX)	Yes
<b>COM-32</b>	Output 2	Output 1	32	0000 to 57FF (HEX)		-	000A (HEX)	Yes
<b>COM-33</b>	Output 3	Output 1	33	0000 to 57FF (HEX)		-	000A (HEX)	Yes
<b>COM-34</b>	Output 4	Output 1	34	0000 to 57FF (HEX)		-	000A (HEX)	Yes
<b>COM-35</b>	Output 5	Output 1	35	0000 to 57FF (HEX)		-	000A (HEX)	Yes
<b>COM-36</b>	Output 6	Output 1	36	0000 to 57FF (HEX)		-	000A (HEX)	Yes
<b>COM-37</b>	Output 7	Output 1	37	0000 to 57FF (HEX)		-	000A (HEX)	Yes
<b>COM-38</b>	Output 8	Output 1	38	0000 to 57FF (HEX)		-	000A (HEX)	Yes
<b>COM-40</b>	Number of input	Input Num	40	0 to 8		1	2	Yes
<b>COM-41</b>	Input 1	Input 1	41	0000 to 57FF (HEX)		-	000A (HEX)	Yes
<b>COM-42</b>	Input 2	Input 2	42	0000 to 57FF (HEX)		-	000A (HEX)	Yes
<b>COM-43</b>	Input 3	Input 3	43	0000 to 57FF (HEX)		-	000A (HEX)	Yes
<b>COM-44</b>	Input 4	Input 4	44	0000 to 57FF (HEX)		-	000A (HEX)	Yes
<b>COM-45</b>	Input 5	Input 5	45	0000 to 57FF (HEX)		-	000A (HEX)	Yes
<b>COM-46</b>	Input 6	Input 6	46	0000 to 57FF (HEX)		-	000A (HEX)	Yes
<b>COM-47</b>	Input 7	Input 7	47	0000 to 57FF (HEX)		-	000A (HEX)	Yes
<b>COM-48</b>	Input 8	Input 8	48	0000 to 57FF (HEX)		-	000A (HEX)	Yes
<b>COM-52</b>	Modbus-RTU mode	ModBus Mode	52	Modbus-RTU		-	ModBus-RTU	Yes
<b>COM-99</b>	Return Code	not displayed	99	Not available	[PROG/ENT] or [SHIFT/ESC]	-	1	Yes

7. Application Group [APP]

Code	Description	Keypad Display		Setting Range		Units	Factory Default	Adjustable during run
		LCD	7-segment	LCD	7-segment			
<b>APP-00</b>	Jump to desired code #	Jump code	Not Displayed	0 to 99	Not available	1	1	Yes
<b>APP-01</b>	Application mode	App Mode	1	None	0	1	0 (None)	No
				Traverse	1			
				MMC	2			
				DRAW	3			
<b>APP-02</b>	Traverse operation band	Trv. Amp	2	0.0 to 20.0 [%]		0.1	0.0 [%]	Yes
<b>APP-03</b>	Traverse scramble band	Trv. Scr	3	0.0 to 50.0 [%]		0.1	0.0 [%]	Yes
<b>APP-04</b>	Traverse acceleration time	Trv Acc Time	4	0.1 to 6000 [sec]		0.1	2.0 [sec]	Yes
<b>APP-05</b>	Traverse deceleration time	Trv Dec Time	5	0.1 to 6000 [sec]		0.1	3.0 [sec]	Yes
<b>APP-06</b>	Traverse offset High	Trv Off Hi	6	0.0 to 20.0 [%]		0.1	0.0 [%]	Yes
<b>APP-07</b>	Traverse offset Low	Trv Off Lo	7	0.0 to 20.0 [%]		0.1	0.0 [%]	Yes
<b>APP-08</b>	No. of Aux. Motor in running	Aux Mot Run	8	#		-	#	-
<b>APP-09</b>	Start aux. Motor	Start Aux	9	1 to 4		1	1	Yes
<b>APP-10</b>	Operation time display by auto-change	Auto Op Time	10	#		0.01	#	-
<b>APP-11</b>	Starting frequency of Aux. Motor 1	Start freq 1	11	0 to FU1-20 (Max.freq)		0.01	49.99 [Hz]	Yes
<b>APP-12</b>	Starting frequency of Aux. Motor 2	Start freq 2	12	0 to FU1-20 (Max.freq)		0.01	49.99 [Hz]	Yes
<b>APP-13</b>	Starting frequency of Aux. Motor 3	Start freq 3	13	0 to FU1-20 (Max.freq)		0.01	49.99 [Hz]	Yes
<b>APP-14</b>	Starting frequency of Aux. Motor 4	Start freq 4	14	0 to FU1-20 (Max.freq)		0.01	49.99 [Hz]	Yes

## 7. Application Group [APP]

Code	Description	Keypad Display		Setting Range		Units	Factory Default	Adjustable during run
		LCD	7-segment	LCD	7-segment			
<b>APP-17</b>	Starting frequency of Aux. Motor 3	Stop freq 3	17	0 to FU1-20 (Max.freq)		0.01	15.00 [Hz]	Yes
<b>APP-18</b>	Starting frequency of Aux. Motor 4	Stop freq 4	18	0 to FU1-20 (Max.freq)		0.01	15.00 [Hz]	Yes
<b>APP-19</b>	Aux.Motor starting delay time	Aux start DT	19	0.0 to 9999 [sec]		0.1	60.00 [sec]	Yes
<b>APP-20</b>	Aux.Motor stop delay time	Aux stop DT	20	0.0 to 9999 [sec]		0.1	60.00 [sec]	Yes
<b>APP-21</b>	Number of Aux. Motor	Nbr Aux' s	21	0 to 4		1	4	Yes
<b>APP-22</b>	Bypass selection	Regul Bypass	22	None Yes	0 1	1	0 (None)	Yes
<b>APP-23</b>	Sleep delay	Sleep Delay	23	0.0 to 9999 [sec]		0.1	60.00 [sec]	Yes
<b>APP-24</b>	Sleep frequency	Sleep Freq	24	0 to FU1-20 (Max.freq)		0.01	19.00 [Hz]	Yes
<b>APP-25</b>	Wakeup level	Wakeup level	25	0.0 to 100.0 [%]		0.1	35.0 [%]	Yes
<b>APP-26</b>	Auto change mode selection	AutoCh_Mode	26	0 to 2		1	1	Yes
<b>APP-27</b>	Auto change time	AutoCh_intv	27	00:00 to 99:00		00 : 01	72:00	Yes
<b>APP-28</b>	Auto change level	AutoCh_Mode level	28	0.0 to 100.0 [%]		0.1	20.0 [%]	Yes
<b>APP-29</b>	Interlock selection	Inter-lock	29	None Yes	0	1	0 (None)	Yes
<b>APP-30</b>	Actual value display	Actal Value	30	#	1	-	#	-
<b>APP-31</b>	Actual value percentage	Actal Perc	31	#	0	-	#	-
<b>APP-32</b>	Draw mode selection	Draw Mod	32	V1_Draw L_Draw V2_Draw	1 2 3	1	0( None)	Yes
<b>APP-33</b>	Draw percentage selection	DrawPerc	22	0.0 to 150.0 [%]		0.1	00.0 [%]	Yes

### Note)Sub-Board Selection Guide according to its Function

Code	Function Description	Keypad Display		Sub-Board Type		
		LCD	7-segment	Sub-A Board	Sub-A Board	Sub-C Board
<b>EXT-01</b>	Sub-board selection	Sub B/D	1	●	●	●
<b>EXT-02</b>	Multi-function Input Terminal `P4`	P4 define	2	●	●	●
<b>EXT-03</b>	Multi-function Input Terminal `P5`	P5 define	3	●	●	●
<b>EXT-04</b>	Multi-function Input Terminal `P6`	P6 define	4	●	●	●
<b>EXT-05</b>	V2 Mode selection	V2 mode	5	●	●	●
<b>EXT-06</b>	Filtering Time Constant for V2 Input Signal	V2 filter	6	●	●	●
<b>EXT-07</b>	V2 Input Minnmm Voltage	V2 volt x1	7	●	●	●
<b>EXT-08</b>	Frequency corresponding to V2 Input Minnmm Voltage	V2 freq y1	8	●	●	●
<b>EXT-09</b>	V2 Input Maximum Voltage	V2 volt x2	9	●	●	●
<b>EXT-10</b>	Frequency corresponding to V2 Input Maximum Voltage	V2 freq y2	10	●	●	●
<b>EXT-14</b>	Usage for Pulse Input Signal	F mode	14	●	●	●
<b>EXT-15</b>	Pulse Input Signal selection	F pulse set	15	●	●	●
<b>EXT-16</b>	Encoder Pulse selection	F pulse num	16	●	●	●
<b>EXT-17</b>	Filtering Time Constant for pulse Input Signal	F filter	17	●	●	●
<b>EXT-18</b>	Pulse Input Minimum Frequency	F pulse x1	18	●	●	●
<b>EXT-19</b>	Frequency Output corresponding to Pulse Input Minimum Frequency	f freq y1	19	●	●	●
<b>EXT-20</b>	Pulse Input Maximum Frequency	F pulse x2	20	●	●	●
<b>EXT-21</b>	Frequency Output corresponding to Pulse Input Minimum Frequency	f freq y2	21	●	●	●
<b>EXT-22</b>	P-Gain for PG Option	PG P-gain	22	●	●	●
<b>EXT-23</b>	I-Gain for PG Option	PG I-gain	23	●	●	●
<b>EXT-24</b>	Slip Frequency for PG Option	PG Slip freq	24	●	●	●
<b>EXT-30</b>	Multi-function Output Terminal `Q1`	q1 define	30	●	●	●
<b>EXT-31</b>	Multi-function Output Terminal `Q2`	q2 define	31	●	●	●
<b>EXT-32</b>	Multi-function Output Terminal `Q3`	q3 define	32	●	●	●
<b>EXT-34</b>	LM (Load Meter) Output selection	LM mode	34	●	●	●
<b>EXT-35</b>	LM (Load Meter) Output Adjustment	LM adjust	35	●	●	●
<b>EXT-40</b>	AM1 (Analog Meter1) Output selection	AM1 mode	40	●	●	●
<b>EXT-41</b>	AM1 (Analog Meter1) Output Adjustment	AM1 adjust	41	●	●	●
<b>EXT-42</b>	AM2 (Analog Meter2) Output selection	Am2 mode	42	●	●	●
<b>EXT-43</b>	AM2(Analog Meter2) Output Adjustment	AM2 adjust	43	●	●	●

[1] Code FU1-08 through FU1-11 appears only when FU1-07 is set at 'DC-brake'.

[2] Code FU1-24 through FU1-25 appears only when FU1-23 is set at 'Yes'.

[3] Code FU1-30 through FU1-37 appears only when FU1-29 is set at 'User V/F'.

[4] Code FU1-51 through FU1-53 appears only when FU1-50 is set at 'Yes'.

[5] Code FU2-11 through FU2-16 appears only when FU2-10 is set at 'Yes'.

[6] The rated motor is automatically set according to the inverter model name. If different motor is used, set the rated motor capacity connected.

[7] This value is automatically entered according to the rated motor set in FU2-30. If different, set the correct value as the motor.

[8] The setting range of carrier frequency is decided depending on drives' capacity (over 30kW).

[9] This value is automatically entered according to the rated motor set in FU2-30. If different, set the correct value as the motor.

[10] Code FU2-47 through FU2-60 appears only when FU2-39 is set at 'PID'.

[11] Code FU2-76 appears only when FU2-75 is set at 'Ext.DB-R'.

[12] Code FU2-81 through FU2-90 appears only when one of I/O-12 ~ I/O-14 is set at '2nd function'.

[13] Code/O-46 through I/O-53 are used in Option Board like RS485, Device Net and F-net etc.

[14] The 'Seq#' of code I/O-53 through I/O-60 varies according to the sequence number selected in I/O-51.

The parameter code may be extended to I/O-84 dependon the number of steps set in I/O-52 because the steps can be set up to 8.

## Dimension (mm)

- SV008iS5-2  
SV015iS5-2  
SV022iS5-2  
SV037iS5-2  
SV055iS5-2  
SV075iS5-2  
SV008iS5-4  
SV015iS5-4  
SV022iS5-4  
SV037iS5-4  
SV055iS5-4  
SV075iS5-4

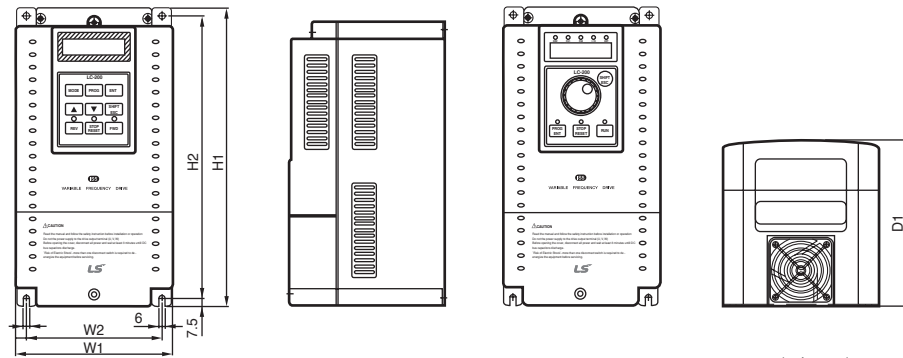

(unit : mm)

Inverter	W1	W2	H1	H2	D2
<b>SV008iS5-2/4</b>	150	130	284	269	156.5
<b>SV015iS5-2/4</b>	150	130	284	269	156.5
<b>SV022iS5-2/4</b>	150	130	284	269	156.5
<b>SV037iS5-2/4</b>	150	130	284	269	156.5
<b>SV055iS5-2/4</b>	200	180	355	340	182.5
<b>SV075iS5-2/4</b>	200	180	355	340	182.5

- SV110iS5-2  
SV150iS5-2  
SV185iS5-2  
SV220iS5-2  
SV110iS5-4  
SV150iS5-4  
SV185iS5-4  
SV220iS5-4

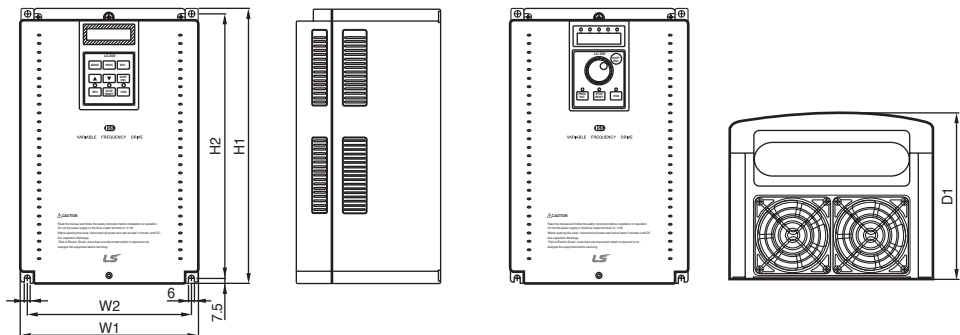

(unit : mm)

Inverter	W1	W2	H1	H2	D2
<b>SV110iS5-2/4</b>	250	230	385	370	201
<b>SV150iS5-2/4</b>	250	230	385	370	201
<b>SV185iS5-2/4</b>	304	284	460	445	234
<b>SV220iS5-2/4</b>	304	284	460	445	234

- SV300iS5-2  
SV370iS5-2  
SV450iS5-2  
SV550iS5-2  
SV300iS5-4  
SV370iS5-4  
SV450iS5-4  
SV550iS5-4  
SV750iS5-4

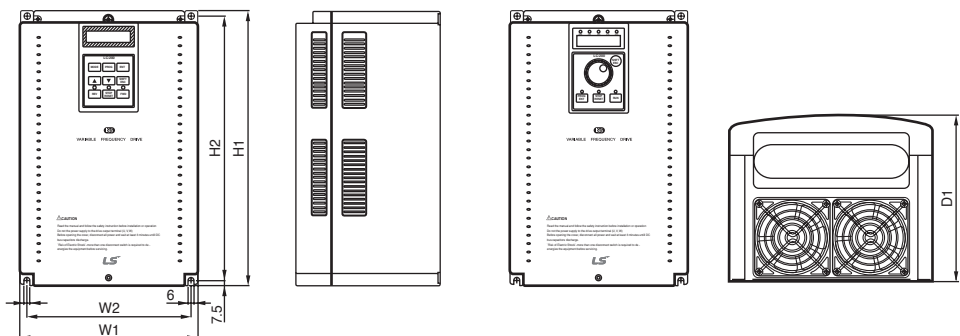

(unit : mm)

Class	Type	W1	W2	W3	H1	H2	D1	D2
200-230V	<b>SV300iS5-2</b>	375	360	275	615	593.5	277.5	230.5
	<b>SV370iS5-2</b>	375	360	275	615	593.5	277.5	230.5
	<b>SV450iS5-2</b>	375	360	275	780	758.5	300.7	230.5
	<b>SV550iS5-2</b>	375	360	275	780	758.5	300.7	230.5
380-480V	<b>SV300iS5-4</b>	350	319.2	270	680	662	311.2	256.6
	<b>SV370iS5-4</b>	350	319.2	270	680	662	311.2	256.6
	<b>SV450iS5-4</b>	375	359.6	275	780	760.5	329	259
	<b>SV550iS5-4</b>	375	359.6	275	780	760.5	329	259
	<b>SV750iS5-4</b>	375	359.6	275	780	760.5	329	259

## Options

Option	Name	Description		
Internal Installation	Sub Board	Sub-A Board (Extended I/O)	Extended I/O module 3 multi-function inputs (P4, P5, P6) 3 multi-function outputs (Q1, Q2, Q3) Auxiliary analog frequency reference (V2) Lm (Load meter) Output (0 ~ 10V)	
		Sub-B Board (speed Feedback)	Encoder pulse input-Speed feedback (AOC, BOC /A+, A-, B+ B-) Encoder pulse output (FBA, FBB)	
		Sub-C Board (Extended I/O)	Extended I/O module 3 multi-function inputs (P4, P5, P6) 1 multi-function outputs (Q1) Isolated auxiliary analog frequency reference (V2) 2 Isolated analog meter output (AM1.AM2)	
	Option Board	Device Net	Embedded DeviceNet protocol Can Control Inverter Connection : Max.64 Input Voltage : DC 11 ~25V Baud Rate : 125, 250, 500k bps CSMA/CD-NBA method	
		PLC Communication (F-Net)	Connection with Fnet communication module of GLOFA PLC Inverter Connection : Max.64 Baud Rate : Max. 1M bps Token method	
		RS-485	RS-485 Communication Inverter Connection : Max.32 Baud Rate : Max. 19200 bps	
		Profi-Bus	Connection to Profibus network Device Type : Profibus Dp Slave Inverter Connection : Max. 64 Baud Rate : Max. 12M bps	
		ModBus-RTU	ModBus-RTU Communication Inverter Connection : Max. 32 Baud Rate : Max.19200bps	
	External Installation	Keypad	LCD	32 Character display Download and Upload from the keypad
			LED (7-segment)	6 digit 7-segment display
Remote Cable		Remote Cable	2m, 3m, 5m long keypad cables for separate keypad installation.	
Dynamic Braking		DB Resistor	Enables inverter to decelerate rapidly	
	DB Unit	DB units are provided as an option for 15~75kW inverters		

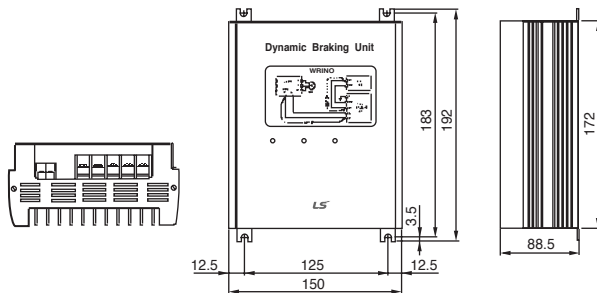

## Dynamic braking (DB)unit

Model Name	SV150DBU-2	SV220DBU-2	SV370DBU-2	SV550DBU-4	SV150DBU-4	SV220DBU-4	SV370DBU-4	SV550DBU-4	SV750DBU-4
Max. DC Input Voltage	DC400V	DC400V	DC400V	DC400V	DC800V	DC800V	DC800V	DC800V	DC800V
Application Motor [kW]	15 20 25 30	30 37 45 55	15 20 25 30 37 45 55	15 20 25 30 37 45 55	15 20 25 30 37 45 55	15 20 25 30 37 45 55	15 20 25 30 37 45 55	15 20 25 30 37 45 55	15 20 25 30 37 45 55
DB Resistor	Wattage [kW]*		2.4 2.4 3.6	6.4 6.4 9.6 9.6	22.4	3.6	6.4	9.6	12.8
	Resistor Value [Ω]		15 10 5	4.2 2.8	4030	20	16.9	11.4	8.4
Average Braking Torque	150%	150%	100%	100%	150%	150%	150%	100%	100%
Enable Duty (ED)	50%	50%		10%	10%	10%	10%	10%	10%
Output Signal	Heat sink over-heat signal output								
Protection	Heat sink over-heat output cut-off								
Environment Ambient Temp.	-10°C ~ 40°C								
Humidity	Below 90% Relative Humidity (Non Condensing)								
Altitude	Less than 3,300ft (1,000m) without derating								
Cooling Method	Self-cooling								
Installation	Avoid corrosive gas, oil mist, flammable gas and dust								

\*This resistor wattage is based on 150% braking torque and 5% ED. Double the wattage in case of using with 10% ED application.

## Dynamic braking (DB) unit

### 1. Internal (built-in) resistors

The DB resistors are built-in for 0.75 ~ 3.7kW models.

Model Name	kW	Internal DB Resistor	ED / Continuous Braking time
SV008iS5-2	0.75	200 Ω, 100Watt	3% / 5seconds
SV015iS5-2	1.5	100 Ω, 100Watt	3% / 5seconds
SV022iS5-2	2.2	60 Ω, 100Watt	2% / 5seconds
SV037iS5-2	3.7	40 Ω, 100Watt	2% / 5seconds
SV008iS5-2	0.75	900 Ω, 100Watt	3% / 5seconds
SV015iS5-2	1.5	450 Ω, 100Watt	3% / 5seconds
SV022iS5-2	2.2	300 Ω, 100Watt	2% / 5seconds
SV037iS5-2	3.7	200 Ω, 100Watt	2% / 5seconds

\*Above table is based on 100% braking torque

### 2. External (optional) resistors

Model Name	kW	DB Resistor (100% Braking Torque)	DB Resistor (150% Braking Torque)
SV008iS5-2	0.75	200 Ω, 100Watt	150 Ω, 150Watt
SV015iS5-2	1.5	100 Ω, 200Watt	60 Ω, 300Watt
SV022iS5-2	2.2	60 Ω, 300Watt	50 Ω, 400Watt
SV037iS5-2	3.7	40 Ω, 500Watt	33 Ω, 600Watt
SV055iS5-2	5.5	3 Ω, 700Watt	20 Ω, 800Watt
SV075iS5-2	7.5	20 Ω, 1000Watt	15 Ω, 1200Watt
SV110iS5-2	11	15 Ω, 1400Watt	10 Ω, 2400Watt
SV150iS5-2	15	11 Ω, 2000Watt	8 Ω, 2400Watt
SV185iS5-2	18.5	9 Ω, 2400Watt	5Ω, 3600Watt
SV220iS5-2	22	8 Ω, 2800Watt	5Ω, 3600Watt
SV300iS5-2	30	4.2 Ω, 6400Watt	-
SV370iS5-2	37	4.2 Ω, 6400Watt	-
SV450iS5-2	45	2.8 Ω, 9600Watt	-
SV550iS5-2	55	2.8 Ω, 9600Watt	-
SV008iS5-4	0.75	900 Ω, 100Watt	600 Ω, 150Watt
SV015iS5-4	1.5	450 Ω, 200Watt	300 Ω, 300Watt
SV022iS5-4	2.2	300 Ω, 300Watt	200 Ω, 400Watt
SV037iS5-4	3.7	200 Ω, 500Watt	130 Ω, 600Watt
SV055iS5-4	5.5	120 Ω, 700Watt	85 Ω, 1000Watt
SV075iS5-4	7.5	90 Ω, 1000Watt	60 Ω, 1200Watt
SV110iS5-4	11	60 Ω, 1400Watt	40 Ω, 2000Watt
SV150iS5-4	15	45 Ω, 2000Watt	30 Ω, 2400Watt
SV185iS5-4	18.5	35 Ω, 2400Watt	20 Ω, 3600Watt
SV220iS5-4	22	30 Ω, 2800Watt	20 Ω, 3600Watt
SV300iS5-4	30	16.9 Ω, 6400Watt	-
SV370iS5-4	37	16.9 Ω, 6400Watt	-
SV450iS5-4	45	11.4 Ω, 9600Watt	-
SV550iS5-4	55	11.4 Ω, 9600Watt	-
SV750iS5-4	75	8.4 Ω, 12800Watt	-

\*Above table is based on 100% braking torque

## Peripheral Devices

Inverter Models	HP	MCCB, ELB	Magnetic Contactor	Wire, mm2 (AWG)			AC Input Fuse	AC Reactor	DC Reactor
				R,S,T	U,V,W	Ground			
SV008iS5-2	1	ABS33a, EBS33	SMC-10P	2 (14)	2 (14)	3.5 (12)	10A	2.13mH, 5.7A	7.00mH, 5.7A
SV015iS5-2	2	ABS33a, EBS33	SMC-10P	2 (14)	2 (14)	3.5 (12)	15A	1.20mH, 10A	4.05mH, 9.2A
SV022iS5-2	3	ABS33a, EBS33	SMC-15P	2 (14)	2 (14)	3.5 (12)	25A	0.88mH, 14A	2.92mH, 13A
SV037iS5-2	5	ABS33a, EBS33	SMC-20P	3.5 (12)	3.5 (12)	3.5 (12)	40A	0.56mH, 20A	1.98mH, 19A
SV055iS5-2	7.5	ABS53a, EBS53	SMC-25P	5.5 (10)	5.5 (10)	5.5 (10)	40A	0.39mH, 30A	1.37mH, 29A
SV075iS5-2	10	ABS63a, EBS63	SMC-35P	8 (8)	8 (8)	5.5 (10)	50A	0.28mH, 40A	1.05mH, 38A
SV110iS5-2	15	ABS103a, EBS103	SMC-50P	14 (6)	14 (6)	14 (6)	70A	0.20mH, 59A	0.74mH, 56A
SV150iS5-2	20	ABS103a, EBS103	SMC-65P	22 (4)	22 (4)	14 (6)	100A	0.15mH, 75A	0.57mH, 71A
SV185iS5-2	25	ABS203a, EBS203	SMC-80P	30 (3)	30 (3)	22 (4)	100A	0.12mH, 96A	0.49mH, 91A
SV220iS5-2	30	ABS203a, EBS203	SMC-100P	38 (2)	30 (3)	22 (4)	125A	0.10mH, 112A	0.42mH, 107A
SV300iS5-2	40	ABS203a, EBS225	GMC-150	60	60	22	150A	0.08mH, 134.2A	0.35mH, 152.0A
SV370iS5-2	50	ABS203a, EBS225	GMC-180	60	60	22	200A	0.07mH, 160.6A	0.3mH, 180.0A
SV450iS5-2	60	ABS403a, EBS300	GMC-220	100	100	38	250A	0.06mH, 198.0A	0.28mH, 221.0A
SV550iS5-2	75	ABS403a, EBS350	GMC-300	100	100	38	300A	0.05mH, 242.0A	0.25mH, 270.0A
SV008iS5-4	1	ABS33a, EBS33	SMC-10P	2 (14)	2 (14)	2 (14)	6A	8.63mH, 2.8A	28.62mH, 2.7A
SV015iS5-4	2	ABS33a, EBS33	SMC-10P	2 (14)	2 (14)	2 (14)	10A	4.81mH, 4.8A	16.14mH, 4.6A
SV022iS5-4	3	ABS33a, EBS33	SMC-20P	2 (14)	2 (14)	2 (14)	10A	3.23mH, 7.5A	11.66mH, 7.1A
SV037iS5-4	5	ABS33a, EBS33	SMC-20P	3.5 (12)	2 (14)	2 (14)	20A	2.34mH, 10A	7.83mH, 10A
SV055iS5-4	7.5	ABS33a, EBS33	SMC-20P	3.5 (12)	2 (14)	3.5 (12)	20A	1.22mH, 15A	5.34mH, 14A
SV075iS5-4	10	ABS33a, EBS33	SMC-20P	5.5 (10)	3.5 (12)	3.5 (12)	30A	1.14mH, 20A	4.04mH, 19A

## Peripheral Devices

Inverter Models	kW	MCCB, ELB	Magnetic Contactor	Wire, mm2 (AWG)			AC Input Fuse	AC Reactor	DC Reactor
				R,S,T	U,V,W	Ground			
<b>SV110iS5-4</b>	15	ABS53a, EBS53	SMC-20P	8 (8)	5.5 (10)	8 (8)	35A	0.81mH, 30A	2.76mH, 29A
<b>SV150iS5-4</b>	20	ABS63a, EBS63	SMC-25P	14 (6)	8 (8)	8 (8)	45A	0.61mH, 38A	2.18mH, 36A
<b>SV185iS5-4</b>	25	ABS103a, EBS103	SMC-35P	14 (6)	8 (8)	14 (6)	60A	0.45mH, 50A	1.79mH, 48A
<b>SV220iS5-4</b>	30	ABS103a, EBS103	SMC-50P	22 (4)	14 (6)	14 (6)	70A	0.39mH, 58A	1.54mH, 55A
<b>SV300iS5-4</b>	40	ABS203a, EBS125	GMC-85	22	22	14	100A	0.33mH, 67.1A	1.19mH, 76.0A
<b>SV370iS5-4</b>	50	ABS203a, EBS150	GMC-100	22	22	14	100A	0.27mH, 82.5A	0.98mH, 93.0A
<b>SV450iS5-4</b>	60	ABS203a, EBS175	GMC-125	38	38	22	100A	0.22mH, 100.1A	0.89mH, 112.0A
<b>SV550iS5-4</b>	75	ABS203a, EBS225	GMC-150	38	38	22	150A	0.18mH, 121.0A	0.75mH, 135.0A
<b>SV750iS5-4</b>	100	ABS203a, EBS225	GMC-180	60	60	22	200A	0.13mH, 167.2A	0.44mH, 187.0A

## RFI Filter

IS5 Series			Footprinting Filter							
Inverter	Power	Code	Current	Tension Voltage	Leakage Current	Dimensions L W H	Mounting Y X	Weight	Mount	Output Chokes
<b>THREE PHASE</b>			<b>NOM.</b>	<b>MAX.</b>						
<b>SV008iS5-2</b>	0.75kW	<b>FFS5-T012-(X)</b>	12A	250VA	0.3A 18A	329 X 149.5 X 50	315 X 120		M5	FS-2
<b>SV015iS5-2</b>	1.5kW									
<b>SV022iS5-2</b>	2.2kW	<b>FFS5-T020-(X)</b>	20A	250VA	0.3A 18A	329 X 149.5 X 50	315 X 120		M5	FS-2
<b>SV037iS5-2</b>	3.7kW									
<b>SV055iS5-2</b>	5.5kW	<b>FFS5-T030-(X)</b>	30A	250VA	0.3A 18A	415 X 199.5 X 60	410 X 160		M5	FS-2
<b>SV075iS5-2</b>	7.5kW									
<b>SV110iS5-2</b>	11kW	<b>FFS5-T050-(X)</b>	50A	250VA	0.3A 18A	415 X 199.5 X 60	410 X 160		M5	FS-2
<b>SV150iS5-2</b>	15kW									
<b>SV185iS5-2</b>	18kW	<b>FFS5-T030-(X)</b>	120A	250VA	0.3A 18A				M5	FS-3
<b>SV220iS5-2</b>	22kW									
<b>SV008iS5-4</b>	0.75kW	<b>FFS5-T006-(X)</b>	6A	380VA	0.5A 27A	329 X 149.5 X 50	315 X 120		M5	FS-1
<b>SV015iS5-4</b>	1.5kW									
<b>SV022iS5-4</b>	2.2kW	<b>FFS5-T012-(X)</b>	12A	380VA	0.5A 27A	329 X 149.5 X 50	315 X 120		M5	FS-2
<b>SV037iS5-4</b>	3.7kW									
<b>SV055iS5-4</b>	5.5kW	<b>FFS5-T030-(X)</b>	30A	380VA	0.5A 27A	415 X 199.5 X 60	401 X 160		M5	FS-2
<b>SV075iS5-4</b>	7.5kW									
<b>SV110iS5-4</b>	11kW	<b>FFS5-T051-(X)</b>	51A	380VA	0.5A 27A	466 X 258 X 65	515.5 X 255		M8	FS-2
<b>SV150iS5-4</b>	15kW									
<b>SV185iS5-4</b>	18kW	<b>FFS5-T060-(X)</b>	60A	380VA	0.5A 27A	541 X 332 X 65	515.5 X 255		M8	FS-2
<b>SV220iS5-4</b>	22kW									

IS5 Series			Standard Filter							
Inverter	Power	Code	Current	Tension Voltage	Leakage Current	Dimensions L W H	Mounting Y X	Weight	Mount	Output Chokes
<b>THREE PHASE</b>			<b>NOM.</b>	<b>MAX.</b>						
<b>SV008iS5-2</b>	0.75kW	<b>FE-T012-(X)</b>	12A	250VA	0.3A 18A	250 X 110 X 60	238 X 76		--	FS-2
<b>SV015iS5-2</b>	1.5kW									
<b>SV022iS5-2</b>	2.2kW	<b>FE-T020-(X)</b>	20A	250VA	0.3A 18A	270 X 140 X 60	258 X 106		--	FS-2
<b>SV037iS5-2</b>	3.7kW									
<b>SV055iS5-2</b>	5.5kW	<b>FE-T030-(X)</b>	30A	250VA	0.3A 18A	270 X 140 X 60	258 X 106		--	FS-2
<b>SV075iS5-2</b>	7.5kW									
<b>SV110iS5-2</b>	11kW	<b>FE-T050-(X)</b>	50A	250VA	0.3A 18A	270 X 140 X 60	258 X 106		--	FS-2
<b>SV150iS5-2</b>	15kW									
<b>SV185iS5-2</b>	18kW	<b>FE-T100-(x)</b>	100A	250VAC	0.3A 18A	420 X 200 X 130	408 X 166		--	FS-3
<b>SV220iS5-2</b>	22kW									
<b>SV300iS5-2</b>	30kW	<b>FE-T150-2</b>	150A	250VAC	1.3A 150A	480 X 200 X 160	468 X 166		--	FS-3
<b>SV370iS5-2</b>	37kW									
<b>SV450iS5-2</b>	45kW	<b>FE-T170-2</b>	170A	250VAC	1.3A 150A	480 X 200 X 160	468 X 166		--	FS-3
<b>SV550iS5-2</b>	55kW									
<b>SV008iS5-4</b>	0.75kW	<b>FE-T230-2</b>	230A	250VAC	1.3A 150A	580 X 250 X 205	560 X 170		--	FS-4
<b>SV015iS5-4</b>	1.5kW									
<b>SV022iS5-4</b>	2.2kW	<b>FE-T260-2</b>	280A	250VAC	1.3A 150A	580 X 250 X 205	560 X 170		--	FS-4
<b>SV037iS5-4</b>	3.7kW									
<b>SV055iS5-4</b>	5.5kW	<b>FE-T006-(X)</b>	6A	380VAC	0.5A 27A	250 X 110 X 60	238 X 76		--	FS-2
<b>SV075iS5-4</b>	7.5kW									
<b>SV110iS5-4</b>	11kW	<b>FE-T012-(X)</b>	12A	380VAC	0.5A 27A	250 X 110 X 60	238 X 76		--	FS-2
<b>SV150iS5-4</b>	15kW									
<b>SV185iS5-4</b>	18kW	<b>FE-T030-(X)</b>	30A	380VAC	0.5A 27A	270 X 140 X 60	258 X 106		--	FS-2
<b>SV220iS5-4</b>	22kW									
<b>SV300iS5-4</b>	30kW	<b>FE-T050-(X)</b>	50A	380VAC	0.5A 27A	270 X 140 X 90	258 X 106		--	FS-2
<b>SV370iS5-4</b>	37kW									
<b>SV450iS5-4</b>	45kW	<b>FE-T060-(X)</b>	60A	380VAC	0.5A 27A	270 X 140 X 90	258 X 106		--	FS-2
<b>SV550iS5-4</b>	55kW									
<b>SV008iS5-4</b>	0.75kW	<b>FE-T070-(X)</b>	70A	380VAC	0.5A 27A	350 X 180 X 90	338 X 146		--	FS-2
<b>SV015iS5-4</b>	1.5kW									
<b>SV022iS5-4</b>	2.2kW	<b>FE-T070-(X)</b>	70A	380VAC	0.5A 27A	350 X 180 X 90	338 X 146		--	FS-2
<b>SV037iS5-4</b>	3.7kW									
<b>SV055iS5-4</b>	5.5kW	<b>FE-T070-2</b>	70A	380VAC	1.3A 150A	350 X 180 X 90	338 X 146		--	FS-3
<b>SV075iS5-4</b>	7.5kW									
<b>SV110iS5-4</b>	11kW	<b>FE-T100-2</b>	100A	38VAC	1.3A 150A	425 X 200 X 130	408 X 166		--	FS-3
<b>SV150iS5-4</b>	15kW									
<b>SV185iS5-4</b>	18kW	<b>FE-T120-2</b>	120A	38VAC	1.3A 150A	425 X 200 X 130	408 X 166		--	FS-3
<b>SV220iS5-4</b>	22kW									
<b>SV300iS5-4</b>	30kW	<b>FE-T120-2</b>	120A	38VAC	1.3A 150A	425 X 200 X 130	408 X 166		--	FS-3
<b>SV370iS5-4</b>	37kW									
<b>SV450iS5-4</b>	45kW	<b>FE-T170-2</b>	170A	38VAC	1.3A 150A	480 X 200 X 160	468 X 166		--	FS-3
<b>SV550iS5-4</b>	55kW									
<b>SV750iS5-4</b>	75kW									

(X) (1) Industrial environment EN 50081-1 (A class)  
 (2) Domestic and industrial environment EN 50081-1 (B class)

**Dimensions**

**FF Series (Footprint)**

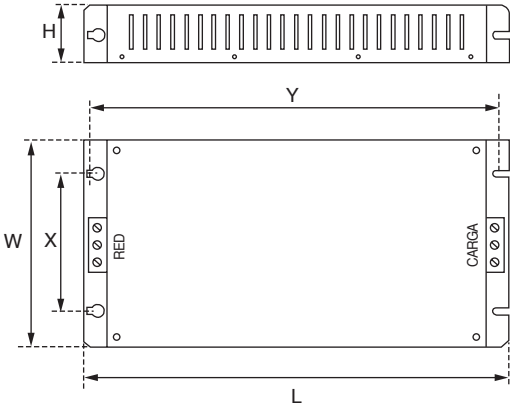

**FE Series (Standard)**

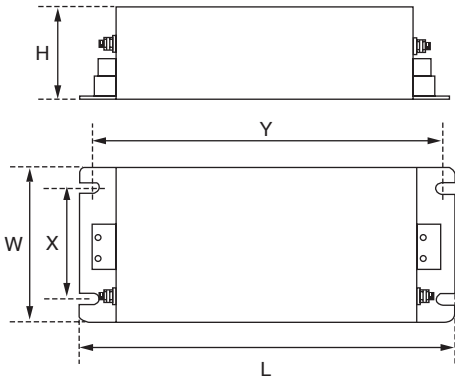

**FS Series (output chokes)**

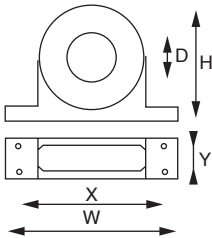

Type	D	W	H	X	O
FS-1	21	85	46	70	5
FS-2	28.5	105	62	90	5
FS-3	48	150	110	125 x 30	5
FS-4	58	200	170	180 x 45	5

**RFI Filter**

**FF Series (Footprint)**

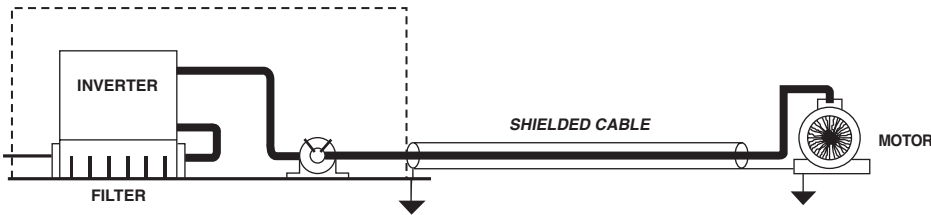

**FE Series (Standard)**

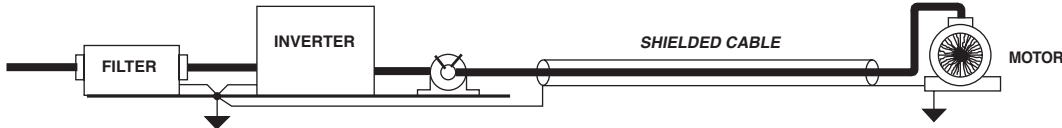



## Green Innovators of Innovation



### Safety Instructions

- For your safety, please read user's manual thoroughly before operating.
- Contact the nearest authorized service facility for examination, repair, or adjustment.
- Please contact a qualified service technician when you need maintenance. Do not disassemble or repair by yourself!
- Any maintenance and inspection shall be performed by the personnel having expertise concerned.

## LSIS Co., Ltd.

© 2003.2 LSIS Co.,Ltd. All rights reserved.

[www.lsis.biz](http://www.lsis.biz)

### ■ HEAD OFFICE

LS Tower 1026-6, Hogue-dong, Dongan-gu, Anyang-si,  
Gyeonggi-do 431-848, Korea

- Middle East +82-2-2034-4901 / bonseongk@lsis.biz
- Europe & Africa +82-2-2034-4376 / ywsohn@lsis.biz
- Asia Pacific +82-2-2034-4645 / sungkyup@lsis.biz

### ■ Global Network

- **LSIS (Middle East) FZE** >> **Dubai, U.A.E.**  
Address: LOB 19 JAFZA VIEW TOWER Room 205, Jebel Ali Freezone P.O. Box 114216, Dubai, United Arab Emirates  
Tel: 971-4-886 5360 Fax: 971-4-886-5361 e-mail: jungyongl@lsis.biz
- **Dalian LSIS Co., Ltd.** >> **Dalian, China**  
Address: No.15, Liaohexi 3-Road, Economic and Technical Development zone, Dalian 116600, China  
Tel: 86-510-8534-6666 Fax: 86-411-8730-7560 e-mail: lixk@lsis.com.cn
- **LSIS (Wuxi) Co., Ltd.** >> **Wuxi, China**  
Address: 102-A, National High & New Tech Industrial Development Area, Wuxi, Jiangsu, 214028, P.R.China  
Tel: 86-510-8534-6666 Fax: 86-411-8730-7560 e-mail: xuhg@lsis.com.cn
- **LSIS-VINA Co., Ltd.** >> **Hanoi, Vietnam**  
Address: Nguyen Khe - Dong Anh - Ha Noi - Viet Nam  
Tel: 84-4-882-0222 Fax: 84-4-882-0220 e-mail: srjo@lsisvina.com
- **LSIS-VINA Co., Ltd.** >> **Hochiminh, Vietnam**  
Address: 41 Nguyen Thi Minh Khai Str. Yoco Bldg 4th Floor, Hochiminh City, Vietnam  
Tel: 84-8-3822-7941 Fax: 84-8-3822-7942 e-mail: sbpark@lsisvina.com
- **LSIS Tokyo Office** >> **Tokyo, Japan**  
Address: 16th, Higashi-Kan, Akasaka Twin Tower, 2-17-22, Akasaka, Minato-ku, Tokyo, Japan  
Tel: 81-3-3582-9128 Fax: 81-3-3582-2667 e-mail: jschuna@lsis.biz
- **LSIS Shanghai Office** >> **Shanghai, China**  
Address: Room E-G, 12th Floor Huamin Empire Plaza, No.726, West Yan'an Road Shanghai 200050, P.R. China  
Tel: 86-21-5237-9977 (609) Fax: 89-21-5237-7191 e-mail: jinhk@lsis.com.cn
- **LSIS Beijing Office** >> **Beijing, China**  
Address: B-Tower 17FL.Beijing Global Trade Center B/D, No.36, BeiSanHuanDong-Lu, DongCheng-District, Beijing 100013, P.R. China  
Tel: 86-10-5825-6025,7 Fax: 86-10-5825-6026 e-mail: cuixiaorong@lsis.com.cn
- **LSIS Guangzhou Office** >> **Guangzhou, China**  
Address: Room 1403,14F,New Poly Tower,2 Zhongshan Liu Road,Guangzhou, P.R. China  
Tel: 86-20-8326-6764 Fax: 86-20-8326-6287 e-mail: linsz@lsis.biz
- **LSIS Chengdu Office** >> **Chengdu, China**  
Address: Room 1701 17Floor, huanminhanjun international Building, No1 Fuxing Road Chengdu, 610041, P.R. China  
Tel: 86-28-8670-3101 Fax: 86-28-8670-3203 e-mail: yangcf@lsis.com.cn
- **LSIS Qingdao Office** >> **Qingdao, China**  
Address: 7B40,Haixin Guangchang Shenye Building B, No.9, Shandong Road Qingdao 26600, P.R. China  
Tel: 86-532-8501-6568 Fax: 86-532-583-3793 e-mail: lirj@lsis.com.cn



Specifications in this catalog are subject to change without notice due to continuous product development and improvement.